



Animal Care Systems

Product Catalog | 2012



Innovative Caging Solutions

Manufacturer of OptiMICE, ErgoMICE,
OptiRAT, and M.I.C.E. Rodent Caging Systems
www.AnimalCareSystems.com

Table of Contents

*To locate a specific part or part number, Ctrl F will open a 'Find' window in which to enter the search item and take you directly to that product or part.

| | |
|---|-----|
| The Opti Carousel Caging System | 3-4 |
| Introduction — Rack/Cage Performance, Warranty, Installation | 5 |
| Recommended Air Flow Charts | 6-7 |
| Rack Assemblies, Cage Specifications | 8 |
| Opti Part Number Overview, Options | 9 |

| | |
|--|-------|
| OptiMICE and ErgoMICE | 11-24 |
| Overview, Features and Benefits | 11 |
| OptiMICE and ErgoMICE Rack Assemblies — Standard | 12-15 |
| Rack Options | 16-17 |
| OptiMICE and ErgoMICE Rack Assemblies — Automatic Watering | 18-19 |
| Customers who order OptiMICE and ErgoMICE racks also purchase | 20 |
| Cage Assemblies | 21 |
| Single-use Cages | 22 |
| Cage Sub-assemblies | 23-24 |

| | |
|---|-------|
| OptiMICE and ErgoMICE Accessories | 25-28 |
| Universal and Opti Accessories | 29-31 |
| Ventilation | 32-33 |
| Parts | 34-35 |

| | |
|--|-------|
| OptiRAT | 37-42 |
| Overview, Features and Benefits | 37 |
| OptiRAT Rack Assemblies — Standard | 38 |
| OptiRAT Rack Assemblies — Automatic Watering | 39-40 |
| Customers who order OptiRAT racks also purchase | 40 |
| Cage Assemblies | 41 |
| Cage Sub-assemblies | 42 |

| | |
|--------------------------------------|-------|
| OptiRAT Accessories | 43-45 |
| Universal and Opti Accessories | 46-48 |
| Ventilation | 49-50 |
| Parts | 51 |

| | |
|---|-------|
| The Original M.I.C.E. System | 53-70 |
| Overview | 54 |
| Rack Footprints | 55-56 |
| Rack Assemblies, Standard, for Mice | 57-58 |
| Rack Assemblies, Standard, for Rats | 59-60 |
| Rack Assemblies — Automatic Watering and Accessories | 61-62 |
| Customers who order The Original M.I.C.E. System racks also purchase | 63 |
| Ventilation | 64-65 |
| Cage Assemblies | 66-67 |
| Cage Sub-assemblies | 68-70 |

| | |
|--|-------|
| M.I.C.E. System Accessories | 71-73 |
| Universal Accessories | 75-76 |
| Parts | 77-80 |

| | |
|---------------------------------------|--------|
| Technical Specifications | 81-108 |
| OptiMICE/ErgoMICE | 83-90 |
| OptiRAT | 91-92 |
| The Original M.I.C.E. System | 93-108 |

| | |
|--|---------|
| Cirrus SPF Misting Station by Animal Care Systems | 109-110 |
|--|---------|

The Opti Carousel Caging System



Based on the patented direct exhaust ventilation technology originally used in the successful M.I.C.E.[®] System, the OptiMICE[®], ErgoMICE[®], and OptiRAT[®] carousel design provides the highest cage density in the industry. The OptiMICE[®] optimizes the value and density equation with 47 mice per square foot of rack footprint, 14.3 rats (< 400 gm).

As with the M.I.C.E.[®] System, all Opti racks are free of noise, odors and allergens. HVAC-driven, heat loads from motors and blowers are eliminated. Add the advantage of light weight and easy maintenance, and the Opti carousel caging system maximizes efficiency.

All Opti racks can be positioned against a wall or next to another rack. By rotating the carousel using conveniently located handles on each platter, cages are easily accessed. There's no need to waste space with unnecessary aisles, and no need to move racks for better cage access. Simply stand in one place and bring the cage to you.

All Opti rack and cage assemblies are sold with water bottles. Other watering options are available. Automatic watering for the OptiMICE[®], ErgoMICE[®], and OptiRAT[®] is available with either Edstrom or SE Lab Group valves. The optional automatic watering system is offered with the valves on rack or on the cages, or with removable valves on the rack.

Opti cages are available in clear polycarbonate or autoclavable amber or smoke polysulfone. Grey carousel platters (cage shelves) are standard. Black platters are available as another option.

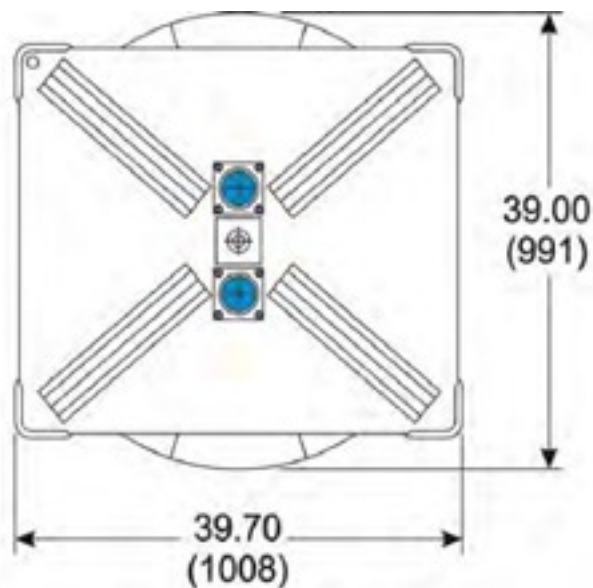

Top View of an Opti Rack
Complete complement of cages

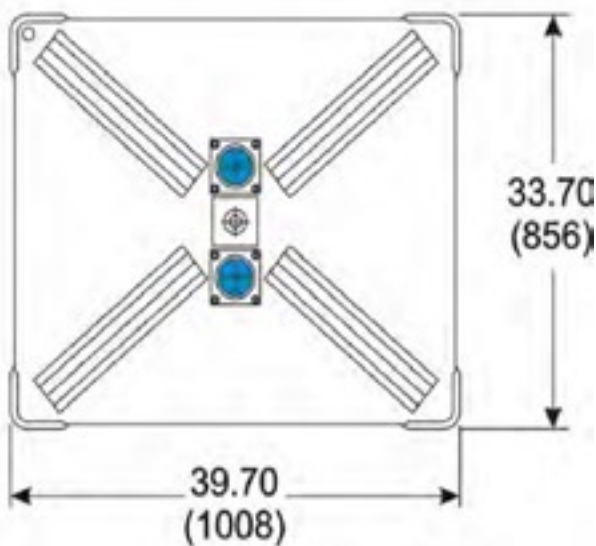

Top View of an Opti Rack
Some cages removed for door clearance

Notes:

1. Overall rack width may be further reduced to 33.00 (838) by removing qty. 8 corner bumpers.
2. All dimensions in inches (mm).
3. ErgoMICE 50, ErgoMICE 70, and ErgoMICE 80 have an identical footprint.
4. Exhaust hose locations shown on racks in blue.

Animal Care Systems, Inc.

Manufacturer of the, OptiMICE[®], ErgoMICE[®], OptiRAT[®], and M.I.C.E.[®] Systems

Introduction

OptiMICE[®], ErgoMICE[®], OptiRAT[®], and M.I.C.E.[®] Systems comprise Exhaust Ventilated Closed-System Cage Racks, including cages for mice, rats, hamsters, and guinea pigs. The equipment is used to carry out world-class biomedical research, testing, and education as well as technology development. The OptiMICE[®], ErgoMICE[®], OptiRAT[®], and M.I.C.E.[®] Systems are cost-effective, Barrier-at-Cage-Level systems that provide source control of contaminants, exhaust ventilation, stress-free environment, and superior ergonomics. Animal Care Systems is the front-runner in caging for providing the healthiest, happiest animals and users in the world. Housing provided by OptiMICE[®], ErgoMICE[®], OptiRAT[®], and M.I.C.E.[®] closed-system cages on EVC racks is a primary component of caring for animals, their users and their environment, as well as for quality of science.

Rack and Cage Performance

The OptiMICE[®], ErgoMICE[®], OptiRAT[®], and M.I.C.E.[®] systems are negative pressure ventilated racks for isolation and containment that use the building's HVAC exhaust for moving fresh air through the cages and out of the room. Closed-system cages are individually ventilated and have integrated environmental enrichment structures. The cages require changing once every two (2) to three (3) weeks, thus minimizing disturbances to the mice and optimizing personnel use. There is no air leakage in or out of the closed-system cages, except through filtered low-supply/high-exhaust vent ports. When the HVAC exhaust is connected to a rack, room air is filtered into each cage, drawn through the rack, and exhausted from the room. The movement of air inside each cage has a one-pass airflow pattern. Absolute filter units filter air in and out of each cage. The spunbonded polyester filter units are highly efficient when racks are operated at recommended low-pressure and low-velocity in supplying at least 20 total-volume air changes per hour (ACH) at cage level. All exhaust is expelled directly by the building exhaust system. This eliminates any blowers on racks, and translates to completely silent systems without any additional motor heat load. The direct connection to the room exhaust system ensures that heat loads and odors generated by animals are exhausted outside the room, while allergens and other airborne pollutants are captured at the cage level where air exits through exhaust filtered vent port. This reduces the need for high room air exchanges. A room air exchange rate between 10 to 12 ACH will suffice and provide a clean-room environment.

Warranty

All OptiMICE[®], ErgoMICE[®], OptiRAT[®], and M.I.C.E.[®] systems and system parts and components are designed for sanitization and sterilization. All of Animal Care Systems, Inc. polycarbonate cages and polycarbonate accessories are warranted against defects in materials and workmanship for one (1) year or twenty five (25) 250° F. maximum temperature autoclave cycles from the date of delivery, whichever occurs first. Polysulfone cages and accessories are warranted against defects in materials and workmanship for two (2) years or fifty (50) 275° F. maximum temperature autoclave cycles from the date of delivery, whichever occurs first. This includes all thermoplastic caging, i.e., cage tops, cage bottoms, water bottles, or other thermoplastic components. The guarantee, from date of delivery, will be against breakage during normal use; cracking, hazing, crazing or other defects. Units showing such defects shall be replaced at no cost to the customer. All other parts are warranted for one (1) year from the date of purchase. This warranty is limited to replacement of defective parts if used in accordance with manufacturer-recommended washing and autoclaving procedures. Sterilization of parts at temperature extremes higher than the manufacturer's recommended maximum will void the warranty for those parts.

Installation

The installation of the OptiMICE[®], ErgoMICE[®], OptiRAT[®], and M.I.C.E.[®] systems will be completed by an authorized Animal Care Systems, Inc. representative at no additional labor charge to the customer. On occasions where animal holding rooms need reconfiguration of ducting and/or exhaust, the customer may incur a nominal charge for duct work or other parts needed to complete the installation.

Recommended Airflow Measurements For OptiMICE®, ErgoMICE®, OptiRAT®, and M.I.C.E.® Racks

Each Animal Care Systems rack should be tested after installation to ensure that airflow through the rack meets or exceeds minimum flow requirements. Racks holding small rodents should achieve at least 15-20 Air Changes per Hour (ACH) after hookup to the animal room exhaust. 30 ACH will allow longer cage-changing periods and requires more airflow through the cages. Larger rodents such as rats and guinea pigs require higher airflows due to the greater evaporative transpiration from the animals. The tables below identify both the MINIMUM and the RECOMMENDED hose air velocity measurement for achieving good airflows in the M.I.C.E., OptiMICE, ErgoMICE, and OptiRAT racks. Minimum flows are equivalent to 15-20 ACH with mice cages. Recommended flows are approximately 25-30 ACH. M.I.C.E. rat racks and OptiRAT racks require higher minimum airflows due to increased cage volume and housed animal mass.

Airflow measurements noted in the tables below must be made with an M79210 ACS Anemometer to assure accuracy. Contact Animal Care Systems for assistance if an installation does not achieve the noted MINIMUM values noted in the table.

***Single-use**

| OptiMICE / ErgoMICE / OptiRAT Rack Airflow Data | | | | | |
|--|-----------------------|--|--|--|--|
| Rack Size | Hoses Per Rack | MINIMUM Air Volume Needed From Rack Exhaust | MINIMUM Anemometer Measurement Per Hose | RECOMMENDED Air Volume Needed From Rack Exhaust | RECOMMENDED Anemometer Measurement Per Hose |
| OptiMICE – 100 Cage | 2 | 40 CFM *60 CFM | 3.5 m/s *5.25 m/s | 60 CFM *75 CFM | 5.25 m/s *6.6 m/s |
| ErgoMICE – 80 Cage | 2 | 34 CFM *51 CFM | 3.0 m/s *4.5 m/s | 51 CFM *64 CFM | 4.5 m/s *5.6 m/s |
| ErgoMICE – 70 Cage | 2 | 30 CFM *45 CFM | 2.6 m/s *3.9 m/s | 45 CFM *56 CFM | 3.9 m/s *4.9 m/s |
| ErgoMICE – 50 Cage | 1 | 22 CFM *33 CFM | 3.8 m/s *5.7 m/s | 33 CFM *41 CFM | 5.7 m/s *7.1 m/s |
| | | | | | |
| OptiRAT – 42 Cage | 2 | 55 CFM | 4.8 m/s | 82 CFM | 7.2 m/s |

Note 1: The 50-Cage ErgoMICE racks uses only one hose for ventilation. The other hose connection is capped with an M21080 Ceiling Flange Cap.

Note 2: Readings with asterisks are OptiMICE/ErgoMICE ventilation requirements when using ACS Single-use Cages.

| M.I.C.E. Mouse Rack Airflow Data | | | | | |
|----------------------------------|----------------|---|---|---|---|
| Rack Size | Hoses Per Rack | MINIMUM Air Volume Needed From Rack Exhaust | MINIMUM Anemometer Measurement Per Hose | RECOMMENDED Air Volume Needed From Rack Exhaust | RECOMMENDED Anemometer Measurement Per Hose |
| S1, 14-Cage | 1 | 8 CFM | 1.3 m/s | 12 CFM | 2.0 m/s |
| S2, 28-Cage | 1 | 16 CFM | 2.6 m/s | 24 CFM | 3.9 m/s |
| S3, 42-Cage | 1(2) | 24 CFM | 3.9 m/s | 36 CFM | 5.9 m/s |
| S4, 56 Cage | 2 | 32 CFM | 2.6 m/s | 48 CFM | 3.9 m/s |
| S5, 70-Cage | 2 | 40 CFM | 3.2 m/s | 60 CFM | 4.8 m/s |
| | | | | | |
| D4, 56-Cage | 2 | 32 CFM | 2.6 m/s | 48 CFM | 3.9 m/s |
| D6, 84-Cage | 2 | 48 CFM | 3.9 m/s | 72 CFM | 5.9 m/s |
| D8, 112-Cage | 2(3)* | 64 CFM | 5.2(3.5) m/s | 96 CFM | 7.8(5.25) m/s |
| D10, 140-Cage | 2(3)* | 80 CFM | 6.5(4.3) m/s | 120 CFM | 9.8(6.5) m/s |

*Some situations with less than ideal room ventilation may require three exhaust hoses on D8 112-Cage and D10 140-Cage racks

| M.I.C.E. Rat Rack Airflow Data | | | | | |
|--------------------------------|----------------|---|---|---|---|
| Rack Size | Hoses Per Rack | MINIMUM Air Volume Needed From Rack Exhaust | MINIMUM Anemometer Measurement Per Hose | RECOMMENDED Air Volume Needed From Rack Exhaust | RECOMMENDED Anemometer Measurement Per Hose |
| S1, 7-Cage | 1 | 12 CFM | 1.9 m/s | 18 CFM | 2.9 m/s |
| S2, 14-Cage | 1 | 24 CFM | 3.8 m/s | 36 CFM | 5.7 m/s |
| S3, 21-Cage | 1(2) | 36 CFM | 5.7(2.9) m/s | 54 CFM | 8.5(4.4) m/s |
| S4, 28 Cage | 2 | 48 CFM | 3.8 m/s | 72 CFM | 5.7 m/s |
| S5, 35-Cage | 2 | 60 CFM | 4.9 m/s | 90 CFM | 7.3 m/s |
| | | | | | |
| D4, 28-Cage | 2 | 48 CFM | 3.8 m/s | 72 CFM | 5.7 m/s |
| D6, 42-Cage | 2 | 72 CFM | 5.7 m/s | 108 CFM | 8.5 m/s |
| D8, 56-Cage | 2(3)** | 96 CFM | 7.8(5.2) m/s | 144 CFM | 11.7(7.8) m/s |
| D10, 70-Cage | 2(3)** | 120 CFM | 9.7(6.5) m/s | 180 CFM | 14.5(9.7) m/s |

*Some situations with less than ideal room ventilation may require three exhaust hoses on D8 112-Cage and D10 140-Cage racks

| ACS Anemometer Reading to CFM Cross-Reference | | | | | | | | | |
|---|------|------|------|-------|-------|-------|-------|-------|-------|
| M/S | 1.0 | 1.2 | 1.4 | 1.6 | 1.8 | 2.0 | 2.2 | 2.4 | 2.6 |
| CFM | 11.4 | 13.7 | 16.0 | 18.3 | 20.6 | 22.9 | 25.1 | 27.4 | 29.7 |
| | | | | | | | | | |
| M/S | 2.8 | 3.0 | 3.2 | 3.4 | 3.6 | 3.8 | 4.0 | 4.2 | 4.4 |
| CFM | 32.0 | 34.3 | 36.6 | 38.9 | 41.1 | 43.4 | 45.7 | 48.0 | 50.3 |
| | | | | | | | | | |
| M/S | 4.6 | 4.8 | 5.0 | 5.2 | 5.4 | 5.6 | 5.8 | 6.0 | 6.2 |
| CFM | 52.6 | 54.9 | 57.1 | 59.4 | 61.7 | 64.0 | 66.3 | 68.6 | 70.9 |
| | | | | | | | | | |
| M/S | 6.4 | 6.6 | 6.8 | 7.0 | 7.2 | 7.4 | 7.6 | 7.8 | 8.0 |
| CFM | 73.1 | 75.4 | 77.7 | 80.0 | 82.3 | 84.6 | 86.9 | 89.1 | 91.4 |
| | | | | | | | | | |
| M/S | 8.2 | 8.4 | 8.6 | 8.8 | 9.0 | 9.2 | 9.4 | 9.6 | 9.8 |
| CFM | 93.5 | 95.8 | 98.0 | 100.3 | 102.6 | 104.9 | 107.2 | 109.4 | 111.7 |

Note 1: Readings less than 1.0 M/S indicate less than adequate airflow in any ACS rack.

Note 2: Cross Reference shows rack CFM on racks with two hoses and M/S measurement performed on one of the hoses. For single-hose racks, divide the CFM in the chart by 2.

OptiMICE®

Rack Assemblies:

Each Opti carousel rack consists of an all-stainless steel support structure holding a cage carousel. 100-cage OptiMICE® and 50-, 70-, or 80-cage ErgoMICE® racks hold 10 cages per platter. The OptiRAT® rack holds 42 rat cages in 7 rows of 6 cages per platter. Each carousel boasts platters molded from Noryl, a reinforced, high-temperature FDA approved polymer. Integral features in each platter guide and retain cages in their respective locations on the rack and provide cage ventilation access. The cage carousel rotates on a maintenance-free, low-friction, high-temperature bearing. The four support structure uprights also serve as the best rack handle system available. A high-temperature rotating seal at the top of the cage carousel ensures airtight integrity at all times.

Racks are 39.7" (99 cm) x 39.0" (99cm). OptiRAT® and OptiMICE® 100- and 70-cage racks are 78" (1980 mm) tall. ErgoMICE® 50- and 80-cage racks are 65" tall. Each rack is permanently identified with its model/serial number on the top structure.

Cage Specifications:

OptiMICE® and ErgoMICE® cage floor area totals 75 square inches (484 square cm).

OptiRAT® cage floor area totals 144 square inches (929.03 square cm).

All Opti cage assemblies dock in place by manually sliding into a center guide and engaging with the platter assembly to ensure positive locking.

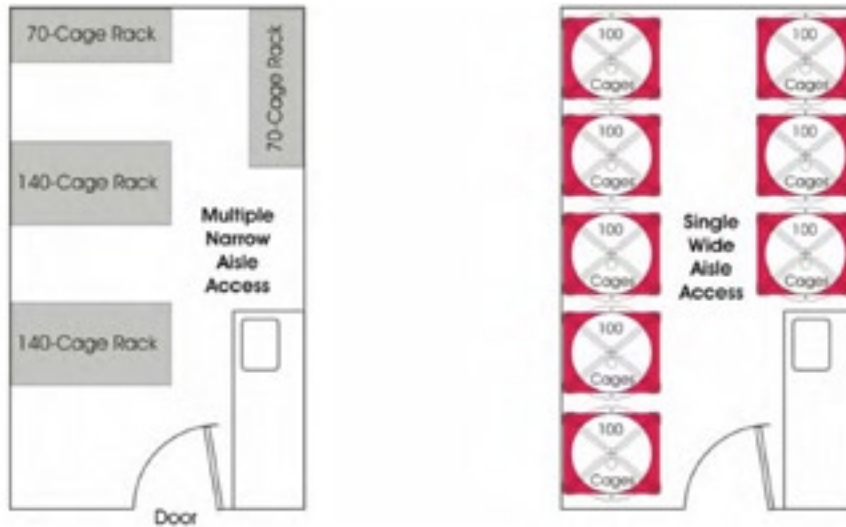

Room Layout Size: 10 X 17
Standard Mouse Rack
Cage Density: 420

Room Layout Size: 10 X 17
OptiMICE Rack
Cage Density: 800

Highest Cage Density in the Industry!

OptiMICE[®], ErgoMICE[®], OptiRAT[®] System

Part Number Overview

All metal parts are Stainless Steel. All plastic cage parts are made of Bayer Makrolon[®] Polycarbonate or Solvay Udel[®] Polysulfone unless otherwise noted.

Part Numbers are Preceded By “C”

Part Numbers Followed By “M” are Clear Polycarbonate

Part Numbers Followed By “P” are Amber Polysulfone

Part Numbers Followed By “S” are Smoke Polysulfone

M.I.C.E.[®] System cages are not available in Smoke Polysulfone

Water Supply

Standard: Bottle Assembly

Options

Sac n Pac option accommodates both commonly available water bags.

Automatic watering is available on all 100-cage OptiMICE[®] and on the 80-cage ErgoMICE[®].

Available with one of the following automatic watering systems:

Edstrom Valve on cage

Edstrom Valve on rack

Edstrom Removable Valve on rack

SE Lab Group Valve on cage

SE Lab Group Valve on rack

OptiMICE® and ErgoMICE®

OptiMICE® and ErgoMICE® are the most efficient, energy-saving and user-friendly caging systems on the market today, offering:

- Superior biological containment and isolation
- Highest density in the industry
 - 47 mice per square foot
 - 14.3 rats per square foot (based on two 400-gram rats per cage)
- No motors or blowers
- Uses no electricity
- No noise, vibrations
- Odor- and allergen-free
- Energy-saving
- Maximum efficiency
- Lightweight
- Easy to maintain

OptiMICE® and ErgoMICE® can be positioned against a wall or next to another rack. By rotating the carousel using conveniently located handles on each platter, cages are easily accessed. There's no need to waste space with large aisles, and no need to move racks for access. Simply stand in one place and bring the cage to you.

Features:

- One-pass airflow, low-velocity and total volume air change
- Patented direct exhaust ventilation technology
- Ventilated bio-containment without electricity, motors or blowers
- Only four parts: base, top, bottle and feeder (only three parts with automatic watering)
- Optional automatic watering infrastructure built in
- Lightweight: 100-cage rack weighs less than 600 pounds (270 kilograms)

The ErgoMice® System

ErgoMICE® was developed as part of the OptiMICE® family to offer rodent racks that provide even more convenient access to animals. The 50-Cage ErgoMICE® is the most ergonomic, with all 50 cages accessible with a minimum of bending or reaching. The 70-Cage ErgoMICE® offers the same lower overall height, but has cages available down to OptiMICE® levels. Finally, the 80-Cage ErgoMICE® eliminates lower cage rows to minimize bending for access, but is full OptiMICE® height. The 80-Cage ErgoMICE® is available with either Edstrom or SE Lab Group automatic watering systems. These three racks provide for the entire range of ergonomic needs, while maintaining good animal density. Highly visible cage interiors are ideal for quarantine, recovery, breeding, and procedures demanding easy access. All ErgoMICE® racks use OptiMICE® cages, parts and technology.

Single-use Caging

Single-use cages are available for OptiMICE® and ErgoMICE® racks. They are interchangeable with conventional cages on either rack. These lightweight cages are molded from PET, a recyclable plastic easily identifiable by the numeral '1' in the recycling mobius triangle. Single-use cages are available for Edstrom's Sipper Sack®, Lab Product's Hydropac®, and Animal Care System's 300 ml water bottle.

OptiMICE® and ErgoMICE® Accessories

Product-specific accessories are listed in the back of each section, in addition to being listed under Universal and Opti Accessories, if appropriate.

ACS continues to refine our products and develop new accessories to complement them. Animal Care Systems' product catalog is available in PDF format on our website under Technical Information. Please call Animal Care Systems toll-free at 1-888-827-3861 for availability and additional product information.

Animal Care Systems, Inc. Product Catalog | 2012

7086 South Revere Parkway, Centennial, Colorado 80112

Toll Free 888.827.3861 | Telephone 720.283.0177 | Fax 720.283.0179 | www.AnimalCareSystems.com

OptiMICE®/ErgoMICE® Rack Assemblies — Standard

OptiMICE Rack Assembly

C89100M/P/S With grey platters

Available Rack Options

C78500 OptiMICE standard black platter option

C78502 OptiMICE water black platter option

C78550 Ergo50 black platter option

C78570 Ergo70 black platter option

C78580 Ergo80 black platter option

C78582 Ergo80 water black platter option



50-Cage ErgoMICE® Rack

C89150M/P/S Grey Platters

C77250 ErgoMICE Rack grey platters, no cages

Option: Exchange grey platters with black platters.

C78550 ErgoMICE Rack, 50 cages, black platters

Includes complete rack assembly with platters, 50 complete OptiMICE mouse cage assemblies and column flags.

Dimensions: 39.5" L x 39" W x 63.8" H, 388 pounds including cages (1003 mm x 991 mm x 1621 mm, 176kg).

Not available with automatic watering.



70-Cage ErgoMICE® Rack

C89170M/P/S Grey Platters

C77270 ErgoMICE Rack, grey platters, no cages

Option: Exchange grey platters with black platters.

C78570 ErgoMICE Rack, 70 cages, black platters

Includes complete rack assembly with platters, 70 complete OptiMICE mouse cage assemblies and column flags.

Dimensions: 39.5" L x 39" W x 77" H, 463 pounds including cages (1003 mm x 991 mm x 1956 mm, 210kg). Not available with automatic watering.



80-Cage ErgoMICE® Rack

C89180M/P/S Grey Platters

C77280 ErgoMICE Rack, grey platters, no cages

Option: Exchange grey platters with black platters.

C78580 ErgoMICE Rack, 80 cages, black platter option

C78582 ErgoMICE Rack, 80 cages, water black platter option

Includes complete rack assembly with platters. 80 complete OptiMICE mouse cage assemblies and column flags.

Dimensions: 39.5" L x 39" W x 63.8" H, 479 pounds including cages (1003 mm x 991 mm x 1621 mm, 217kg).

Available with water bottles or automatic watering.

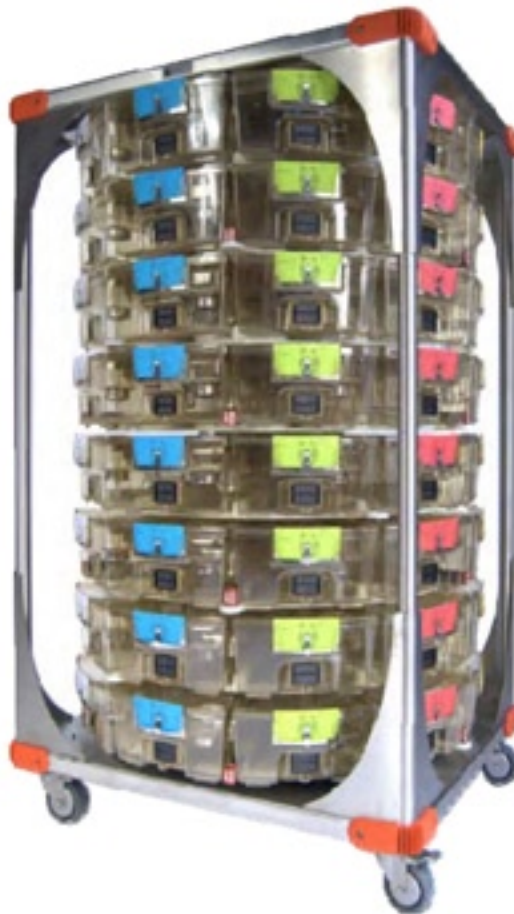

OptiMICE®/ErgoMICE® Available Rack Options

OptiMICE Rack Only

C77200 OptiMICE Rack – Standard (no cages)

Rack Options

- C78010M** Replace clear polycarbonate water bottles with Sac n Pac (specify H for Hydropac® or S for Sipper Sack®: C78010MH or MS)
- C78010P** Replace amber polysulfone water bottles with Sac n Pac (specify H for Hydropac® or S for Sipper Sack®: C78010PH or PS)
- C78010S** Replace smoke polysulfone water bottles with Sac n Pac (specify H for Hydropac® or S for Sipper Sack®: C78010SH or SS)
- C78220M/P/S** Replace standard cage tops with filter cage tops. See Page 27 for details.
- C78231M/P/S** Replace standard cage tops with feed port cage tops. See Page 27 for details.
*Feed port options are also available with ErgoMICE. Contact ACS for details.
Note: Feed port not available with the filter cage top option.
- C78500** OptiMICE (100-cage): Replace grey platters with black (add to the cost of the rack ordered)



C78010M

ErgoMICE Rack Only

- C77250** ErgoMICE Rack — 50-cage version
- C77270** ErgoMICE Rack — 70-cage version
- C77280** ErgoMICE Rack — 80-cage version

ErgoMICE Rack Platter Options

- C78550** Replace grey platters with black (50-cage – add to the cost of the rack ordered)
- C78570** Replace grey platters with black (70- cage – add to the cost of the rack ordered)
- C78580** Replace grey platters with black (80- cage – add to the cost of the rack ordered)

Rack Manual Watering Options — Sac n Pac

- C78015M** Ergo50 – Replace clear polycarbonate water bottles with Sac n Pac (specify H for Hydropac® or S for Sipper Sack®: C78015MH or MS)
- C78015P** Ergo50 – Replace amber polysulfone water bottles with Sac n Pac (specify H for Hydropac® or S for Sipper Sack®: C78015PH or PS)
- C78015S** Ergo50 – Replace smoke polysulfone water bottles with Sac n Pac (specify H for Hydropac® or S for Sipper Sack®: C78015SH or SS)
- C78017M** Ergo70 – Replace clear polycarbonate water bottles with Sac n Pac (specify H for Hydropac® or S for Sipper Sack®: C78017MH or MS)
- C78017P** Ergo70 – Replace amber polysulfone water bottles with Sac n Pac (specify H for Hydropac® or S for Sipper Sack®: C78017PH or PS)
- C78017S** Ergo70 – Replace smoke polysulfone water bottles with Sac n Pac (specify H for Hydropac® or S for Sipper Sack®: C78017SH or SS)
- C78018M** Ergo80 – Replace clear polycarbonate water bottles with Sac n Pac (specify H for Hydropac® or S for Sipper Sack®: C78018MH or MS)
- C78018P** Ergo80 – Replace amber polysulfone water bottles with Sac n Pac (specify H for Hydropac® or S for Sipper Sack®: C78018PH or PS)
- C78018S** Ergo80 – Replace smoke polysulfone water bottles with Sac n Pac (specify H for Hydropac® or S for Sipper Sack®: C78018SH or SS)

Animal Care Systems, Inc. Product Catalog | 2012

7086 South Revere Parkway, Centennial, Colorado 80112

OptiMICE®/ErgoMICE® Available Rack Options

Manual Watering Options, Cont'd.

ACS Water Bag Cage Top Assembly Option

The C79290MH, PH, and SH ACS Water Bag Cage Top Assembly is designed specifically to provide water to animals using a water bag system. Water bag access is provided with a convenient depression in the cage top, allowing water changing without removing the cage top. A stainless steel valve grommet for the water delivery valve is sized for perfect valve fit. Available individually or as cage top, cage assembly, and rack options. Compatible with Lab Products' Hydropac®.

| | |
|-------------------------------------|--|
| C78020MH, C78020PH, C78020SH | OPTiMICE Rack -- Replace Clear Polycarbonate, Amber Polysulfone or Smoke Polysulfone standard cage tops with ACS Water Bag Cage Top Assembly |
| C78025MH, C78025PH, C78025SH | Ergo50 -- Replace Clear Polycarbonate, Amber Polysulfone or Smoke Polysulfone standard cage tops with ACS Water Bag Cage Top Assembly |
| C78027MH, C78027PH, C78027SH | Ergo70 -- Replace Clear Polycarbonate, Amber Polysulfone or Smoke Polysulfone standard cage tops with ACS Water Bag Cage Top Assembly |
| C78028MH, C78028PH, C78028SH | Ergo80 -- Replace Clear Polycarbonate, Amber Polysulfone or Smoke Polysulfone standard cage tops with ACS Water Bag Cage Top Assembly |

OptiMICE®/ErgoMICE® Rack Assemblies — With Automatic Watering

Animal Care Systems' OptiMICE racks offer customers the option of three versions of automatic watering systems.

ErgoMICE automatic watering is available only in the 80-cage rack version.

Cage-mounted valves provide the utility of having valves thoroughly cleaned with the cages without the necessity of separate valve cleaning operations. Cage-mounted valves are available from either Edstrom or SE Lab Group, and interface with a matching QD on the rack.

Rack-mounted valves are also available with either Edstrom or SE Lab valves. OptiMICE systems with rack-mounted valves feature cage-mounted flapper doors. Rack-mounted valves are available in either fixed or removable versions.

Rack Assembly – Edstrom with Cage-mounted Valves

C89300M/P/S OptiMICE – Clear Polycarbonate, Amber Polysulfone, Smoke Polysulfone

Rack assembly includes 100 C79101M/P/S cage assemblies.

C89380M/P/S ErgoMICE 80-cage – Clear Polycarbonate, Amber Polysulfone, Smoke Polysulfone

Rack assembly includes 80 C79101M/P/S cage assemblies.

Rack Assembly – Edstrom with Fixed Rack-mounted Valves

C89302M/P/S OptiMICE – Clear Polycarbonate, Amber Polysulfone, Smoke Polysulfone

Rack assembly includes 100 C79102M/P/S cage assemblies

C89382M/P/S ErgoMICE 80-cage – Clear Polycarbonate, Amber Polysulfone, Smoke Polysulfone

Rack assembly includes 80 C79102M/P/S cage assemblies.

Rack Assemblies – with SE Lab Group Cage-mounted Valves

C89305M/P/S OptiMICE – Clear Polycarbonate, Amber Polysulfone, Smoke Polysulfone

Rack assembly includes 100 C79105M/P/S cage assemblies.

C89385M/P/S ErgoMICE 80-cage – Clear Polycarbonate, Amber Polysulfone, Smoke Polysulfone

Rack assembly includes 80 C79105M/P/S cage assemblies.

Complete Autowater Rack Options

| | |
|---------------|--|
| C78120 | OptiMICE Edstrom removable valve on rack (add to base model C89302X) |
| C78140 | OptiMICE SE Lab Group valve on rack (add to base model C89302X) |
| C78150 | OptiMICE SE Lab Group removable valve on rack (add to base model C89302X) |
| C77602 | OptiMICE Rack adapted for watering (no cages) |
| C77682 | ErgoMICE 80-cage - Water Rack only – No cages, valves or quick-disconnects (QDs) |
| C77301 | OptiMICE Water Rack only – with QD for cage-mounted Edstrom valves |
| C77381 | ErgoMICE 80-cage Rack Assembly – with cage mounted Edstrom valves |
| C77305 | OptiMICE Rack only – with QD for cage-mounted SE Lab Group valves |
| C77385 | ErgoMICE 80-cage Rack Assembly – with cage mounted SE Lab Group valves |
| C77302 | OptiMICE Edstrom rack-mounted water valve |

ACS can tailor other Edstrom or SE Lab Group watering configurations upon request.



Cage-mounted SE Lab Group valve (Edstrom valve similar)



Fixed rack-mounted Edstrom valve (SE Lab valve similar)



Removable rack-mounted Edstrom valve

Water Valve Cap Assembly

M45080A

304 Stainless Steel. Covers watering valve and allows selective cages to be isolated from automatic watering system when using a water bottle. Easy push-on design. Fits all Edstrom cage-mounted valves on both M.I.C.E. and Opti systems.



Edstrom Watering Valve

M45050

Mounted on cage, this valve engages the watering QD on M.I.C.E system racks. 316 stainless steel components with high-temperature polymer seals.



Customers who order OptiMICE and ErgoMICE racks also purchase:

Opti Bottle Washing Basket

C61011

Basket is made of polished, heavy gauge, 304 stainless steel. Rack holds up to 15 bottles. Wash Basket captures bottles so they can be washed and drained upside down. Use with C79121M/P/S and C79122M/P/S bottle assembly.

Dimensions: 19.50 x 12.70 x 3.91



Opti Cage Top Washing Rack

C61020

Rack is made of electropolished heavy gauge 304 stainless steel. Holds up to 20 cage tops for cleaning and drying.

Dimensions: 22.75 x 14.32 x 5

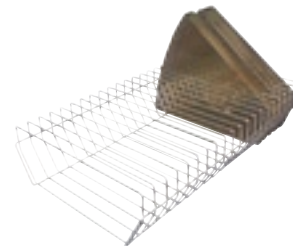

Rack Status Monitor

C79351

ACS Rack Status Monitor is a totally solid-state unit that mounts on any Opti rack and displays the rack airflow in CFM. With no moving parts, it has no spinning impellers that can wear out bearings or fly apart. Installation is a simple matter of mounting the quick-disconnect sending unit in line with one of the exhaust hoses, hanging the display unit at the top of the rack, connecting the USB cable between them, and turning on the unit. Like the racks themselves, the RSM needs no external supply of electricity. Its six AA-sized lithium batteries provide power for many months of 24/7 rack monitoring without replacement.

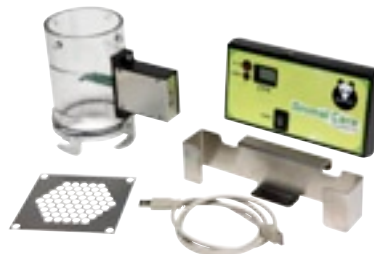

OptiMICE Scruffing Grid

C40230

Scruffing Grid was developed in response to customer requests for a location for handlers to manipulate a mouse directly above the cage after the cage top is removed. This item provides a multi-bar location for animals to grab when being handled for brief procedures. It can be retrofitted to any standard OptiMICE feeder, and once installed, is a permanent feeder fixture allowing feeders to stack. Grid is fabricated from stainless steel.



Complete Change-out Cage Assemblies

See next page

OptiMICE®/ErgoMICE® Cage Assemblies – Standard

All complete cage assemblies include filters, feeder and bottle/valve option.

Standard Cage Assembly

C79100M/P/S Clear Polycarbonate, Amber Polysulfone, Smoke Polysulfone

C79103M/P/S Clear Polycarbonate, Amber Polysulfone, Smoke Polysulfone with Sac n Pac (either version)



C79100S OptiMICE
Cage Assembly, smoke
polysulfone



C79100M OptiMICE
Cage Assembly, clear
polycarbonate



C79100P OptiMICE
Cage Assembly, amber
polysulfone

Cage Assembly Options

Filter Cage Top Option

C78210M/P/S Replace standard cage top with Filter Cage Top

Feed Port Cage Top Option

C78230M/P/S Replace standard cage top with Feed Port Cage Top

ACS Water Bag Cage Top Option

C78240MH/PH/SH Replace standard cage top with ACS Water Bag Cage Top

Autowater Cage Assembly with Edstrom cage-mounted watering valve

C79101M/P/S Clear Polycarbonate, Amber Polysulfone, Smoke Polysulfone

Autowater Cage Assembly (for Edstrom or SE Lab rack-mounted automatic watering valve)

C79102M/P/S Clear Polycarbonate, Amber Polysulfone, Smoke Polysulfone

Autowater Cage Assembly with SE Lab Group cage-mounted watering valve

C79105M/P/S Cage Assembly with SE Lab Group watering valve –
Clear Polycarbonate, Amber Polysulfone, Smoke Polysulfone

Single-use Cages

Racks for disposable cages: See C77200 for standard rack 'NO CAGES'

Sterilized single-use cages are available in boxes of 16 complete assemblies with choice of cage tops.

Sterilized single-use cage base assemblies are available in boxes of 16 cage base assemblies only.

OptiMICE and ErgoMICE

| | |
|----------------------|--|
| DBASE.BED | Single-use Cage Base Assembly only – With bedding (sold 16 per box) |
| DBASE | Single-use Cage Base Assembly only – No bedding (sold 16 per box) |
| DCAGE.BOT.BED | Complete Single-use Cage Assembly for 300 ml water bottle – With bedding (sold 16 per box – Bottle assembly sold separately) |
| DCAGE.BOT | Complete Single-use Cage Assembly for 300 ml water bottle – No bedding (sold 16 per box – Bottle assembly sold separately) |
| DCAGE.HYD.BED | Complete Single-use Cage Assembly for Hydropac® – With bedding (sold 16 per box – Hydropac® not included) |
| DCAGE.HYD | Complete Single-use Cage Assembly for Hydropac® – No bedding (sold 16 per box – Hydropac® not included) |
| DCAGE.SIP.BED | Complete Single-use Cage Assembly for Sipper Sack® – With bedding (sold 16 per box – Sipper Sack® not included) |
| DCAGE.SIP | Complete Single-use Cage Assembly for Sipper Sack® – No bedding (sold 16 per box – Sipper Sack® not included) |
| C45400 | Sipper Sack® Valve |
| C45410 | Sipper Sack® Bags (100 per pack) |
| C79722 | Single-use 300 ml Water Bottle Assembly – Includes Bottle and Cap (sold 128 per box) |

Bedding is Harlan Teklad corn cob-based, provided in the cage in pre-packaged, sterilized 20 cu. in. recyclable containers.



Single Use Cage with Sipper Sack®



Single-use complete cage assembly with ACS water bottle and bedding



Single-use 300 ml water bottle



Single-use cage with Hydropac®



Single-use complete cage assembly with ACS water bottle, no bedding

Animal Care Systems, Inc. Product Catalog | 2012

7086 South Revere Parkway, Centennial, Colorado 80112

OptiMICE®/ErgoMICE® Cage Sub-Assemblies

Cage Bottom Assemblies

Standard Cage Bottom Assembly

C79110M/P/S Clear Polycarbonate, Amber Polysulfone, Smoke Polysulfone
Includes one Cage Bottom with two Filter Assemblies installed.



C79110M



C79110P



C79110S

Cage Bottom Assembly with Flapper Door

C79112M/P/S Cage Bottom Assembly for rack-mounted valve – Clear Polycarbonate, Amber Polysulfone, Smoke Polysulfone. Rack-mounted drinking valve is sold separately.

Cage Bottom Assembly for Edstrom Cage Valve

C79111M/P/S Cage Bottom Assembly, valve on cage – Clear Polycarbonate, Amber Polysulfone, Smoke Polysulfone
Includes one Cage Bottom and two Filter Assemblies.

Cage-mounted drinking valves (item M45050 or C45021) sold separately.

C79115M/P/S Cage Bottom Assembly for SE Lab Group Cage Valve



water valve in cage



C79111M



QD

Cage Filter Assembly – standard

C79073 1 complete OptiMICE cage filter assembly.



Cage Top Assemblies**C79290M/P/S**

Cage Top Assembly (with cage clips) –
Clear Polycarbonate, Amber Polysulfone, Smoke Polysulfone

**ACS Water Bag Cage Top Assembly****C79290MH/PH/SH**

Designed to provide water to animals using a water bag system. Water bag access is provided with a convenient depression in the cage top, allowing water changing without removing the cage top. A stainless steel grommet for the water delivery valve is sized for perfect fit. Available individually or as cage top, cage assembly, and rack option. Compatible with Lab Products' Hydropac®.

**C79290FM/FP/FS**

Filter Cage Top Assembly (with cage clips and filter)
– Clear Polycarbonate, Amber Polysulfone, Smoke Polysulfone

**C79292M/P/S**

Cage Top Assembly with Feed Port –
Clear Polycarbonate, Amber Polysulfone, Smoke Polysulfone.
Note: Feed port not available with the filter cage top option.

**Bottle Assemblies****C79122M/P/S**

Complete Bottle Assembly (includes bottle hanger)
– Clear Polycarbonate, Amber Polysulfone, Smoke Polysulfone

C79132M/P/S

Bottle & Seal Assembly (includes bottle hanger)
– Clear Polycarbonate, Amber Polysulfone, Smoke Polysulfone. No bottle cap.



C79132P



C79122P

See Accessories and Parts Sections for Bottle Colors and Individual Bottle Parts

Animal Care Systems, Inc. Product Catalog | 2012

7086 South Revere Parkway, Centennial, Colorado 80112

OptiMICE® and ErgoMICE® Optional Accessories

UniMICE Cage Divider Assembly

C79170M

Divider is an innovative polycarbonate plastic wall that evenly divides a 75 square inch cage exactly in two. Assembly includes divider, clips, and C40102 split feeder. Extra bottle and hanger sold separately.

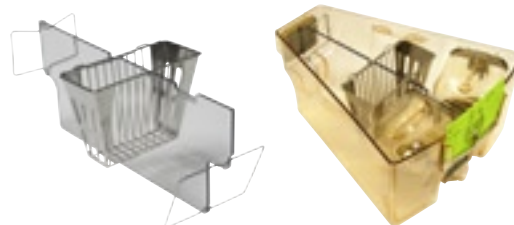

UniMICE Autowater Cage Divider Assembly

C79171

One side retains autowatering, the other side uses the OptiMICE water bottle (water bottle sold separately). Polished stainless steel.



UniMICE Divided Feeders

C40102 Divided Wire Feeder for use with C79170 Cage Divider Assembly

C40104 UniMICE Divided Wire Feeder for Autowater Cage Divider

The divided feeder is a vee-shaped, electropolished stainless steel wire mouse feeder that straddles the cage divider, allowing feeding from either side. Identical in size and shape to the standard C40101 Feeder.

UniMICE Cage Divider Clips

C40160 UniMICE Front Cage Divider Clip

C40161 UniMICE Rear Cage Divider Clip

Clips are stainless steel and snap on the cage divider, securing it in the center of the OptiMICE cage.

UniMICE Autowater Cage Divider Clips

C40162 Front Clip for Autowater Cage Divider

C40163 Rear Clip for Autowater Cage Divider

OptiMICE Large Capacity Wire Feeder

C40103

Feeder is a larger version of the standard feeder. Made from electropolished stainless steel. Capacity: 30 ounces (.89 liters)



OptiMICE J-Feeder

C40180

Replaces standard feeder for use with powder or granular type feed. Electropolished stainless steel with integral flow bars to prevent spillage. Low height allows even juvenile mice access to feed. J-Feeder is designed to clear bedding and tox floor.



OptiMICE Sac n Pac Feeder

C79330H Sac n Pac Feeder (for Lab Products Hydropac®)

C79330S Sac n Pac Feeder (for Edstrom Sipper Sack®)

Feeder is constructed of all stainless steel and fits in the OptiMICE cage in place of the standard feeder and water bottle. It accommodates either the Edstrom Sipper Sack® or the Lab Products Hydropac®.



C79331 OptiMICE Sac n Pac Solo

Replaces water bottle in the Sac n Pac. Positioned next to the ACS standard feeder.



OptiMICE Metering Bottle and Holder Assembly

C79125

This OptiMICE cage accessory provides two 60 cc bottles side-by-side in a special holder that hangs in the cage in place of the standard water bottle. They are ideal for accurate measurement of fluid consumed or preferential drinking studies.



OptiMICE Cage Tox Floor

C40170

Tox Floor is an easily removable, stainless steel floor insert for use with mice where bedding cannot be used. Tox Floor reduces foot injuries common to wire mesh type floors while maintaining maximum headroom.

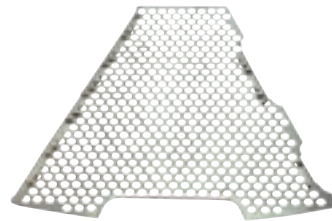

OptiMICE Wire Bar Cage Tox Floor

C40173

The OptiMICE Wire-Bar Tox Floor is precision fabricated from 304 stainless steel, and is electropolished to a bright, uniform finish. The tox floor is perfectly form-fitting in the OptiMICE cage bottom, and stands off from the floor to allow waste products to drop through completely and without hanging up. The open design is durable, and easily handled and washed.



Animal Care Systems, Inc. Product Catalog | 2012

OptiMICE Opti Skid

C79390

Easily slide tall stacks of OptiMICE cages across the washroom floor, while keeping a stable stack. UHMWPE bottom slides across any surface.



ACS Water Bag Cage Top Assembly

C79290MH/PH/SH

Designed to provide water to animals using a water bag system. Water bag access is provided with a convenient depression in the cage top, allowing water changing without removing the cage top. A stainless steel grommet for the water delivery valve is sized for perfect fit. Available individually or as cage top, cage assembly, and rack option. Compatible with Lab Products' Hydropac®.



OptiMICE Filter Cage Top Assembly

C79290F

Developed for customers who need good, passive ventilation during periods when an occupied cage is not on the OptiMICE rack receiving active exhaust ventilation. It may also be used while actively ventilating on the rack. The top assembly uses a standard OptiMICE cage filter, which is easily cleaned and replaced.



OptiMICE Feed Port Cage Top Assembly

C79292

This OptiMICE cage top has the addition of a circular feed port closed with a spring-loaded flapper door. It's designed specifically to accommodate feeding the animals one food pellet at a time. Interchangeable with the standard OptiMICE cage top.



OptiMICE Wire Bar Cage Top Assembly

C79295

Animal Care Systems developed this new accessory specifically for one of our caging customers. The Wire Bar Cage Top gives OptiMICE users the freedom to house animals in an OptiMICE cage without ventilation from the rack. This allows temporary bench-top animal housing after surgery, or any situation requiring housing animals off the OptiMICE rack. The Wire Bar Cage Top temporarily replaces the standard OptiMICE cage top, and provides breathable cage top security when an occupied cage is on the workbench or in an area without active ventilation. Made of electropolished stainless steel, it snaps onto the OptiMICE cage identically to the standard cage top.



OptiMICE Inhalation Cage Top Assembly

C79400

Introduce alternate gas mixtures with top-mounted hose fitting. Can be used with cage on OptiMICE rack.



OptiMICE Scruffing Grid

C40230

Our ACS Scruffing Grid was developed in response to customer requests for a location for handlers to manipulate a mouse directly above the cage after the cage top is removed. This item provides a multi-bar location for animals to grab when being handled for brief procedures. It can be retrofitted to any standard OptiMICE feeder, and once installed, is a permanent feeder fixture allowing feeders to stack. Grid is fabricated from stainless steel.



OptiMICE Cage Card Holder Kit

C79252

The OptiMICE Cage Card Holder Kit provides the user with a stainless steel 3 x 5 card holder mated to an autoclaveable polymer adapter. This kit replaces the standard cage card clip, and allows simple slide-out removal of the card holder itself. In use, the holder can be rotated up 45 degrees for superior card viewing or cage flagging. The adapter snaps securely into place in the OptiMICE cage card cavity and prevents bedding capture.



OptiMICE Precharge Station

C79360 OptiMICE Valve Precharge Station - Edstrom

C79365 OptiMICE Valve Precharge Station - SE Lab Group

Test and pre-charge OptiMICE cage-mounted automatic watering valves during cage changing. This accessory can be configured for Edstrom Industries (P/N C79360) or SE Lab Group valves (P/N C79365).

Rubber feet for no-slip bench-top operation.



Universal and Opti Accessories

Opti Rack Status Monitor

C79351

ACS Rack Status Monitor is a totally solid-state unit that mounts on any Opti rack and displays the rack airflow in CFM. With no moving parts, it has no spinning impellers that can wear out bearings or fly apart. Installation is a simple matter of mounting the quick-disconnect sending unit in line with one of the exhaust hoses, hanging the display unit at the top of the rack, connecting the USB cable between them, and turning on the unit. Like the racks themselves, the RSM needs no external supply of electricity. Its six AA-sized lithium batteries provide power for many months of 24/7 rack monitoring without replacement.



Universal Anemometer Assembly

M79210

Accurately samples the air velocity through an exhaust hose, providing a spot-checking capability for rack exhaust.



ACS Bulk Cart

C79345

Animal Care Systems' transport/storage cart is designed for moving large numbers of our cages at once, but can easily transport other bulk loads. With an all-stainless steel, welded construction and high-temperature, 5-inch casters, it is autoclavable and sturdy enough for long-term, severe service. At 72" long and 31" deep, the completely open side allows for easy loading of up to 400 OptiMICE cages or 128 OptiRAT cages. The cart floor is slightly inclined inwards to further stabilize tall cage stacks. Weight is 175 pounds.



Opti Bottle Basket Cart

C79340

Basket holds multiple C61011 OptiMICE Bottle Baskets for transportation to and from washrooms, autoclaves and cage changing locations. Bottle Baskets may be stacked at least 8-high, for a total bottle capacity of more than 360 bottles. This all-stainless steel cart doubles as a universal washroom cart, and it is completely autoclavable. The Bottle Basket Cart features smooth 4" diameter casters for quiet rolling and a perforated base for quick drainage of water. The Cart is shipped flat.



Opti Bottle Washing Basket

C61011

Basket is made of polished, heavy gauge, 304 stainless steel. Rack holds up to 15 bottles. Wash Basket captures bottles so they can be washed and drained upside down. Use with C79121M/P/S and C79122M/P/S bottle assembly.

Dimensions: 19.50 x 12.70 x 3.91



Opti Cage Top Washing Rack

C61020

Rack is made of electropolished heavy gauge 304 stainless steel. Holds up to 20 cage tops for cleaning and drying.

Dimensions: 22.75 x 14.32 x 5

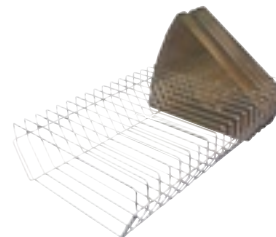

Opti Brake Assembly

C79380

Developed for a customer who requested a means to easily lock the Opti carousel when moving a rack from room to room, the Opti Brake Assembly attaches quickly to any Opti rack vertical handle. It features stainless steel construction and is activated with a quick lever pull. Easily lock the Opti carousel when moving a rack from room to room.

Opti Column Row ID Flag Kit

C79160

This ID kit is included and installed with all OptiMICE racks. Additional flag assemblies are available as an option.



Opti Fail-safe Fan

C80010

Mounts directly on an Opti rack to one hose fitting and can provide emergency rack ventilation for up to 72 hours if animal room ventilation is not available. When used, the other hose fitting is capped. It features a quiet brushless fan powered by three conventional 12-volt drill batteries (included). Batteries are easily removed for charging in the included battery charger.



Opti Fail-safe Battery Charger

C48050

Clean Aire – Double

M83011

Replaces HVAC – for two-hose connection. Includes pre-filter, micro HEPA filter, and 15 pounds (6.8 Kg) of replaceable activated carbon. The Clean Aire features a 400-watt, three-speed motor. It is a quiet, free-standing unit that uses the same hose and coupling system as all ACS equipment. It can quickly be added to any rack to draw room air through the rack when room exhaust is not available.

M83020 Clean Aire HEPA Filter

M83030 Clean Aire Carbon Filter

M83040 Clean Aire Pre-Filter (4-pack)
Replaceable, internal filter.



Bedding Scoop

M65040

Bedding scoop ensures the correct amount of bedding. Two full scoops provide perfect bedding depth in OptiRAT cages.



Colored Opti Bottles

Black opaque and red translucent bottles are used when bottle contents need protection from light.

C79122 PBLK Opti Bottle Assembly, Polysulfone, Black

C79132 PBLK Opti Bottle & Seal Assembly, Polysulfone, Black

C79122 PRED Opti Bottle Assembly, Polysulfone, Red

C79132 PRED Opti Bottle & Seal Assembly, Polysulfone, Red



Black Bottle Assembly



Black Bottle & Seal Assembly



Red Bottle & Seal Assembly
(cap not included)



Red Bottle Assembly

Enrichment

Trough Tunnel

M43040

Pure nylon enrichment device for the animal. Small rodents can hide underneath; it also provides an item for chewing urges.



Universal Ventilation Parts

Universal Ventilation Parts for all ACS racks — OptiMICE/ErgoMICE, OptiRAT and M.I.C.E.

Hi-temp Exhaust Hose Assembly

M79H06 Flex Hose Assembly - Standard 6-Foot Extended Length
Includes 3" diameter hose, two M21041 hose clamps and two M21050 female hose fittings.



Optional High-temp Exhaust Hose Assembly

M79H02 through M79H25

Last two digits indicate hose length. Available in 1-foot increments, from 2' through 10', 12', 15', 20' and 25'.

M21120 3" Hi-Temp Hose. Priced per foot.



Lightweight Flex Hose Assembly

M79056P Optional 5' short length
M79055P Standard 10' length
M79051P Optional 15' extended length
M79052P Optional 20' extended length



Lightweight Flex Hose Only

M21011 Flexible 3" diameter exhaust hose. Priced per foot, maximum of 20'.

Damper

M79190
Controls airflow from a rack exhaust hose. Fits all Animal Care Systems racks.
Flange not included.



Stainless Steel Hose Clamp

M21041-3"

3" Stainless Steel – Used to clamp M21011 hose to M21050 fittings.



Animal Care Systems, Inc. Product Catalog | 2012

7086 South Revere Parkway, Centennial, Colorado 80112

**Hose Fitting, Female, Quick-Disconnect
M21050P-3"**

Connects to each end of M21011 hose using M21041 hose clamp



Ceiling Flange

M21061P

Black Polycarbonate fitting for room exhaust. Fits all ACS Hose Assemblies.



Ceiling Flange Cap

M21080

Quick-connect cap for ceiling flange or ceiling drop adapter.



Rack Simulator Cap

M21081

Quick-connect for ceiling flange or ceiling drop adapter to simulate the ventilation load of a rack and maintain air balance.



Ceiling Drop Adapter

M21090

Black PVC fitting for 3" duct room exhaust. Adapter fits all ACS Hose Assemblies.



Other Ventilation Accessories

M79230

4 x 3 Ceiling Drop Assembly

M79240

4" WYE Duct Assembly

M79235

6 x 3 Ceiling Drop Assembly

M79245

6" WYE Duct Assembly

M79264

Universal Exhaust Box Assembly

The Universal Exhaust Box Assembly is a space-saving, aesthetic alternative to Wye ducts or Tee ducts when installing ACS racks and connecting to ventilation. Installs close to ceiling and is ideal for low-headroom situations. Provides 4 exhaust hose connections to enable ventilation of two racks from one ceiling fitting. Installs quickly to either 4" or 6" animal room ceiling drops. Order M79244 for 4" Exhaust Box Assembly.



M79260

Exhaust Adapter Plate

This adapter plate is custom-designed to fit your ventilation requirements in any animal room with an exhaust grille. Typical plate shown.



Other custom ventilation fillings are available to solve any ventilation situation.

Opti only

Opti Exhaust Grid

C40520

Tailors exhaust air through rack's exhaust flange. Used with C79351 Rack Status Monitor.

Animal Care Systems, Inc. Product Catalog | 2012

7086 South Revere Parkway, Centennial, Colorado 80112

Toll Free 888.827.3861 | Telephone 720.283.0177 | Fax 720.283.0179 | www.AnimalCareSystems.com

OptiMICE® and ErgoMICE® Parts

OptiMICE Cage Card Clip

C40280

The OptiMICE Cage Card Clip is standard in all OptiMICE and ErgoMICE cages. Clip uses light spring pressure to secure the cage card in the OptiMICE cage. The gently curved center spring allows for easy card insertion and removal. Fabricated from polished stainless steel.



C43252 Stainless Steel Cage Card Holder



Card Holder and
Molded Adapter
together



C43250 Molded Cage Card Adapter



*See Page 28 for C79252 OptiMICE Cage Card Holder Kit

ACS Cage Card

M52010

Card is placed in integral card holder at front of cage. Cage Card is printed on front and back. Available in five colors for visual coding: white, red, blue, green and yellow. Card dimension: 3" x 5"



Opti Bottle Cap

C40150

A one-piece, stainless steel bottle cap for use with the OptiMICE Bottle.



OptiMICE Bottle Hanger for C79122M/P/S

C40320

Used on OptiMICE bottles to connect bottle assembly to cage. Included on all OptiMICE bottles.



Opti Bottle Cap Removal Tool

C79190

Tool is made of stainless steel with a soft rubber handle. One tool included per four OptiMICE racks.



OptiMICE Wire Feeder

C40101

Feeder is vee-shaped, electropolished stainless steel.
Capacity: 17 ounces (.51L)



Cage Filter Assembly – standard

C79073

1 complete OptiMICE cage filter assembly.



OptiRAT®

The OptiRAT has the same footprint and height as the OptiMICE, ventilates using the same connections and hoses, and maximizes parts interchangeably. With 42 rat cages arrayed in seven levels of six cages per level, the OptiRAT again sets a standard for animal density, animal comfort, user ergonomics, and overall utility. The cages are cavernous, with more than eight inches of animal headroom and 144 square inches of floor area. With the wide front face, visibility into cages is superior. It uses two standard OptiMICE water bottles and a 1.1 liter (1.2 qt.) stainless steel feeder. Like the OptiMICE, ErgoMICE and M.I.C.E., systems, the OptiRAT uses the same patented ventilation technology, with zero electrical consumption, and no motors or blowers. There are no allergens or odors from the OptiRAT rack. The OptiRAT is available with clear polycarbonate, amber polysulfone, or smoke polysulfone cages.

Like the OptiMICE/ErgoMICE system, the OptiRAT is the most efficient, energy-saving and user-friendly caging system on the market today, offering:

- Superior biological containment and isolation
- Highest density in the industry
- No motors or blowers, no electricity
- No noise, vibrations
- Odor- and allergen-free
- Energy-saving
- Maximum efficiency
- Lightweight
- Easy to maintain

OptiRAT can be positioned against a wall or next to another rack. By rotating the carousel, cages are easily accessed. There's no need to waste space with large aisles, and no need to move racks for access. Simply stand in one place and bring the cage to you.

OptiRAT creates an ideal environment, perfect for breeding, quarantine, bio-exclusion and conventional rodent housing for research.

Features:

- One-pass airflow, low-velocity and total volume air change
- Patented direct exhaust ventilation technology
- Ventilated bio-containment without electricity, motors or blowers
- Only four parts: base, top, water bottles and feeder (only three parts with automatic watering)
- Lightweight: 42-cage rack weighs 550 pounds (250 kilograms)
- Integrated standard 3" x 5" cage card holder

OptiRAT System Information

Two standard OptiMICE water bottles mount to the stainless steel feeder in the OptiRAT cage. The bottles can easily be positioned in four different configurations, depending on your needs. The higher position is ideal for standard rats and guinea pigs, placing the water aperture ~3.1" (80mm) above the cage floor. The lower position accommodates pups and is ~1.5" (39mm) above the cage floor.

OptiRAT Accessories

Many Opti Accessories are compatible with OptiMICE, ErgoMICE and OptiRAT systems.

ACS continues to refine our products and develop new accessories to complement them. An Animal Care Systems product catalog is available in PDF format on our website under Technical Information. Please call Animal Care Systems toll-free at 1-888-827-3861 for availability and additional product information.

OptiRAT® Rack Assemblies - Standard

OptiRAT Rack Assembly

- C86100M Clear Polycarbonate Cages
- C86100P Amber Polysulfone Cages
- C86100S Smoke Polysulfone Cages

OptiRAT® Available Rack Options

- C76200 OptiRAT Rack Only (no cages)
- C75010MH or MS Replace Clear Polycarbonate water bottles with Sac n Pac (specify H for Hydropac® or S for Sipper Sack®)
- C75010PH or PS Replace Amber Polysulfone water bottles with Sac n Pac (specify H for Hydropac® or S for Sipper Sack®)
- C75010SH or SS Replace Smoke Polysulfone water bottles with Sac n Pac (specify H for Hydropac® or S for Sipper Sack®)
- C75010M Replace Clear Polycarbonate water bottles with Watering/Feeder Assembly
- C75010P Replace Amber Polysulfone water bottles with Watering/Feeder Assembly
- C75010S Replace Smoke Polysulfone water bottles with Watering/Feeder Assembly
- C78232M/P/S Add Manual Feed Port Cage Top to OptiRAT cages - Polycarbonate, Amber or Smoke Polysulfone



Animal Care Systems, Inc. Product Catalog | 2012

7086 South Revere Parkway, Centennial, Colorado 80112

OptiRAT® Rack Assemblies With Automatic Watering

Complete OptiRAT (42-cage) Racks with Cage-mounted Edstrom Valves
C86200M/P/S



Water Valve Cap Assembly

M45080A

304 Stainless Steel. Covers watering valve and allows selective cages to be isolated from automatic watering system when using a water bottle. Easy push-on design. Fits all Edstrom cage-mounted valves on both M.I.C.E. and Opti systems.



Edstrom Watering Valve

M45050

Mounted on cage, this valve engages the watering QD on M.I.C.E system racks. 316 stainless steel components with high-temperature polymer seals.



Complete OptiRAT (42-cage) Racks with Rack-mounted Edstrom Valves
C86202M/P/S



**Complete OptiRAT Racks with Cage-mounted SE Lab Group Valves
C86205M/P/S**

**OptiRAT Water Rack Only – No Cages, Valves or QDs (Includes Piping)
C76601** Adapted for watering

**OptiRAT Water Rack Only – No Cages – Complete with Valves or QDs
(Includes Piping)**

C76201 Adapted for cage-mounted Edstrom valves

C76202 Adapted for rack-mounted Edstrom valves

C76205 Adapted for cage-mounted SE Lab Group valves

**Available Options (add to the cost of a complete OptiRAT rack with
rack-mounted Edstrom valves)**

C75120 Edstrom removable valve on rack (add to base model C86202X)

C75140 SE Lab Group valve on rack (add to base model C86202X)

C75150 SE Lab Group removable valve on rack (add to base model
C86202X)



Customers who order OptiRAT racks also purchase:

Opti Bottle Washing Basket

C61011

Basket is made of polished, heavy gauge, 304 stainless steel. Rack holds up to 15 bottles. Wash Basket captures bottles so they can be washed and drained upside down. Use with C79121M/P/S and C79122M/P and S bottle assembly. Dimensions: 19.50 x 12.70 x 3.91



Opti Cage Top Washing Rack

C61020

Rack is made of electropolished heavy gauge 304 stainless steel. Holds up to 20 cage tops for cleaning and drying. Dimensions: 22.75 x 14.32 x 5

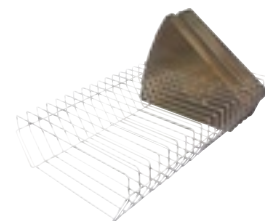

Rack Status Monitor

C79351

ACS Rack Status Monitor is a totally solid-state unit that mounts on any Opti rack and displays the rack airflow in CFM. With no moving parts, it has no spinning impellers that can wear out bearings or fly apart. Installation is a simple matter of mounting the quick-disconnect sending unit in line with one of the exhaust hoses, hanging the display unit at the top of the rack, connecting the USB cable between them, and turning on the unit. Like the racks themselves, the RSM needs no external supply of electricity. Its six AA-sized lithium batteries provide power for many months of 24/7 rack monitoring without replacement.



Complete Change-out Cage Assemblies

See next page

Animal Care Systems, Inc. Product Catalog | 2012

Cage Assemblies

Complete OptiRAT Standard Cage Assemblies

- C79500M/P/S OptiRAT Cage Assembly
- C79501M/P/S With cage-mounted Edstrom watering valve
- C79502M/P/S Rack-mounted valves with flapper door
- C79505M/P/S With cage-mounted SE Lab Group watering valve



Shown with feed and bedding

OptiRAT® Cage Sub-Assemblies

Standard Cage Bottom Assemblies

- C79510M/P/S OptiRAT Cage Bottom Assembly
- C79511M/P/S Ready for cage-mounted valve (H2O valve not included)
- C79512M/P/S Ready for rack-mounted valve



C79510M



C79510P

- C79570 OptiRAT Cage Filter Kit - Sold separately or with cage bottom assembly. Includes 4 filters (2 front, 2 back) and 8 screws.
- C79522 OptiRAT Feed Port Cage Top Assembly.

Cage Top Assemblies

C79520M/P/S



C79520P



C79520M

Bottle Assemblies

- C79122M/P/S Bottle Assembly (use two bottles per cage for OptiRAT. Includes bottle hanger)
- C79132M/P/S Bottle & Seal Assembly only (use two bottles per cage for OptiRAT; cap not included. Includes bottle hanger)
- C79550P Round Bottle Assembly
- C79560P Bottle & Seal Assembly only (use two bottles per cage for OptiRAT; cap not included. Includes bottle Hanger)



C79122P



C79132P



Round Bottle Assembly



Bottle & Seal Assembly

See Accessories and Parts Sections for colored bottles and individual bottle parts

Animal Care Systems, Inc. Product Catalog | 2012

OptiRAT® Optional Accessories

C79175M UniRAT Cage Divider Assembly

Single-house rats at twice the density with the C79175M UniRAT Cage Divider. The sturdy high-temperature polycarbonate divider is easily installed with a single stainless steel wire clip. The divider engages the standard OptiRAT feeder for front support, and effectively allows split feeding. The entire assembly simply drops into place with no tools. One Opti water bottle hangs from each side of the feeder.



C40171 OptiRAT Cage Tox Floor

This easily removable stainless steel floor insert accommodates rat toxicology studies where bedding cannot be used. Our unique design (also used in Original M.I.C.E. and OptiMICE) reduces foot injuries common to wire mesh type floors, and maintains maximum ceiling clearance. 17.1”w x 12.75” l x .38” h.

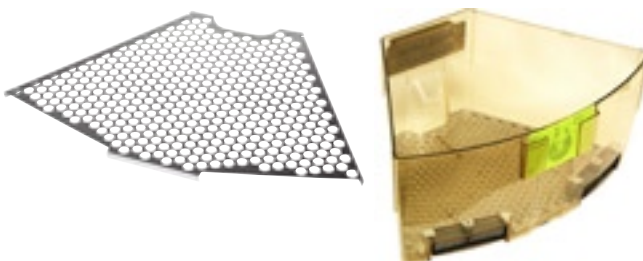

C40174 OptiRAT Wire Bar Cage Tox Floor

The OptiRAT Wire-Bar Tox Floor is precision fabricated from 304 stainless steel, and is electropolished to a bright, uniform finish. The tox floor is perfectly form-fitting in the OptiRAT cage bottom, and stands off from the floor to allow waste products to drop through completely and without hanging up. The open design is durable, and easily handled and washed.

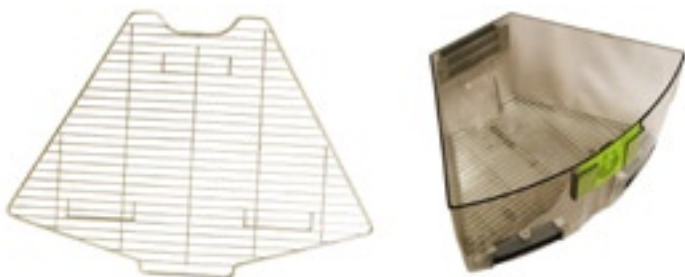

C79522M/P/S OptiRAT Feed Port Cage Top Assembly

Allows manual introduction of feed through a spring-loaded port.
Polycarbonate, Amber or Smoke Polysulfone



C79640 OptiRAT Inhalation Cage Top Assembly

Allows for selective introduction of test gas into a cage.

C79582 OptiRAT Sac n Pac Feeder Kit

The Sac n Pac Assembly consists of a holder that accommodates a watering bag. Holder features a transparent viewing window and mounts saddlebag fashion to the feeder side. Two required per cage. Standard OptiRAT feeder not included.



C79580 Sac n Pac RH

C79581 Sac n Pac LH

C40400 Sac n Pac Feeder

C40405 OptiRAT J-Feeder

Replace the standard pellet feeder with this feeder for use with powdered or granular feed. All stainless steel construction designed to clear bedding and tox floor while still using either the standard water bottle or water bag holders. Particularly useful with guinea pigs.



C40402 OptiRAT Feeder with restrictor plate

Covers bottom feed slots and lower portion of front feed slots to restrict feed access and protect some animals from slot configuration.

Opti Black and Red Bottle and Seal Assemblies

Black opaque and red translucent bottles are used when bottle contents need protection from light.

| | |
|--------------------|---|
| C79122 PBLK | Opti Bottle Assembly, Polysulfone, Black |
| C79132 PBLK | Opti Bottle & Seal Assembly, Polysulfone, Black |
| C79122 PRED | Opti Bottle Assembly, Polysulfone, Red |
| C79132 PRED | Opti Bottle & Seal Assembly, Polysulfone, Red |

Includes one Black or Red Bottle and one C40150 Seal. For rat cages, use two (2) of these 400 ml water bottles. Cap not included.



Black Bottle Assembly



Black Bottle & Seal Assembly



Red Bottle & Seal Assembly (cap not included)



Red Bottle Assembly

OptiRAT Precharge Station

C79361 Valve Precharge Station - Edstrom

C79366 Valve Precharge Station - SE Lab Group

Test and pre-charge OptiRAT cage-mounted automatic watering valves during cage changing. This accessory can be configured for Edstrom Industries (P/N C79361) or SE Lab Group valves (P/N C79366). Rubber feet for no-slip bench-top operation.

OptiRAT Round Bottle Assemblies

C79550M/P/S Round Bottle Assembly

C79560M/P/S Round Bottle & Seal Assembly (no cap)

Note: Round Bottles require C40411 holder.

C40411 Round Bottle Holder

C61015 Round Bottle Basket

C79122 Square Bottle Assembly

C79132 Square Bottle only (no cap)

C40412 Square Bottle Holder

C40151 Guinea Pig Bottle Cap



C79550M/P/S Round Bottle Assembly



C40412 Square Bottle Holder



C40411 Round Bottle Holder (insert) with Holder



C40151 Guinea Pig Cap

Universal and Opti Accessories

Opti Rack Status Monitor

C79351

ACS Rack Status Monitor is a totally solid-state unit that mounts on any Opti rack and displays the rack airflow in CFM. With no moving parts, it has no spinning impellers that can wear out bearings or fly apart. Installation is a simple matter of mounting the quick-disconnect sending unit in line with one of the exhaust hoses, hanging the display unit at the top of the rack, connecting the USB cable between them, and turning on the unit. Like the racks themselves, the RSM needs no external supply of electricity. Its six AA-sized lithium batteries provide power for many months of 24/7 rack monitoring without replacement.

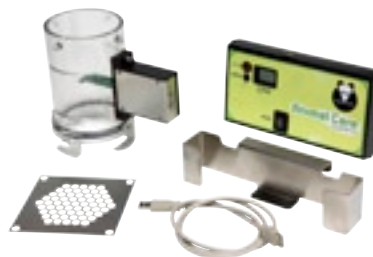

Universal Anemometer Assembly

M79210

Accurately samples the air velocity through an exhaust hose, providing a spot-checking capability for rack exhaust.



ACS Bulk Cart

C79345

Animal Care Systems' transport/storage cart is designed for moving large numbers of our cages at once, but can easily transport other bulk loads. With an all-stainless steel, welded construction and high-temperature, 5-inch casters, it is autoclavable and sturdy enough for long-term, severe service. At 72" long and 31" deep, the completely open side allows for easy loading of up to 400 OptiMICE cages or 128 OptiRAT cages. The cart floor is slightly inclined inwards to further stabilize tall cage stacks. Weight is 175 pounds.



Opti Bottle Basket Cart

C79340

Basket holds multiple C61011 OptiMICE Bottle Baskets for transportation to and from washrooms, autoclaves and cage changing locations. Bottle Baskets may be stacked at least 8-high, for a total bottle capacity of more than 360 bottles. This all-stainless steel cart doubles as a universal washroom cart, and it is completely autoclavable. The Bottle Basket Cart features smooth 4" diameter casters for quiet rolling and a perforated base for quick drainage of water. The Cart is shipped flat.



Opti Bottle Washing Basket

C61011

Basket is made of polished, heavy gauge, 304 stainless steel. Rack holds up to 15 bottles. Wash Basket captures bottles so they can be washed and drained upside down. Use with C79121M/P/S and C79122M/P/S bottle assembly. Dimensions: 19.50 x 12.70 x 3.91



Opti Cage Top Washing Rack

C61020

Rack is made of electropolished heavy gauge 304 stainless steel. Holds up to 20 cage tops for cleaning and drying. Dimensions: 22.75 x 14.32 x 5

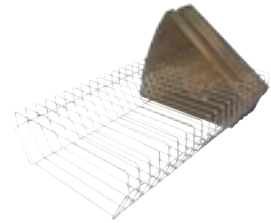

Opti Brake Assembly

C79380

Developed for a customer who requested a means to easily lock the Opti carousel when moving a rack from room to room, the Opti Brake Assembly attaches quickly to any Opti rack vertical handle. It features stainless steel construction and is activated with a quick lever pull. Easily lock the Opti carousel when moving a rack from room to room.

Opti Column Row ID Flag Kit

C79160

This ID kit is included and installed with all OptiMICE racks. Additional flag assemblies are available as an option.



Opti Fail-safe Fan

C80010

Mounts directly on an Opti rack to one hose fitting and can provide emergency rack ventilation for up to 72 hours if animal room ventilation is not available. When used, the other hose fitting is capped. It features a quiet brushless fan powered by three conventional 12-volt drill batteries (included). Batteries are easily removed for charging in the included battery charger.



Opti Fail-safe Battery Charger

C48050

Clean Aire – Double

M83011

Replaces HVAC – for two-hose connection. Includes pre-filter, micro HEPA filter, and 15 pounds (6.8 Kg) of replaceable activated carbon. The Clean Aire features a 400-watt, three-speed motor. It is a quiet, free-standing unit that uses the same hose and coupling system as all ACS equipment. It can quickly be added to any rack to draw room air through the rack when room exhaust not available.



is

M83020 Clean Aire HEPA Filter

M83030 Clean Aire Carbon Filter

M83040 Clean Aire Pre-Filter (4-pack)
Replaceable, internal filter.

Bedding Scoop

M65040

Bedding scoop ensures the correct amount of bedding. Two full scoops provide perfect bedding depth in OptiRAT cages.



Colored Opti Bottles

Black opaque and red translucent bottles are used when bottle contents need protection from light.

C79122 PBLK Opti Bottle Assembly, Polysulfone, Black

C79132 PBLK Opti Bottle & Seal Assembly, Polysulfone, Black

C79122 PRED Opti Bottle Assembly, Polysulfone, Red

C79132 PRED Opti Bottle & Seal Assembly, Polysulfone, Red



Black Bottle Assembly



Black Bottle & Seal
Assembly



Red Bottle & Seal Assembly
(cap not included)



Red Bottle Assembly

Enrichment

Trough Tunnel

M43040

Pure nylon enrichment device for the animal. Small rodents can hide underneath; it also provides an item for chewing urges.



Universal Ventilation Parts

Universal Ventilation Parts for all ACS racks — OptiMICE/ErgoMICE, OptiRAT and M.I.C.E.

Hi-temp Exhaust Hose Assembly

M79H06 Flex Hose Assembly - Standard 6-Foot Extended Length
Includes 3" diameter hose, two M21041 hose clamps and two M21050 female hose fittings.



Optional High-temp Exhaust Hose Assembly

M79H02 through M79H25
Last two digits indicate hose length. Available in 1-foot increments, from 2' through 10', 12', 15', 20' and 25'.

M21120 3" Hi-Temp Hose. Priced per foot.



Lightweight Flex Hose Assembly

M79056P Optional 5' short length
M79055P Standard 10' length
M79051P Optional 15' extended length
M79052P Optional 20' extended length



Lightweight Flex Hose Only

M21011 Flexible 3" diameter exhaust hose. Priced per foot, maximum of 20'.

Damper

M79190
Controls airflow from a rack exhaust hose. Fits all Animal Care Systems racks.
Flange not included.



Stainless Steel Hose Clamp

M21041-3"
3" Stainless Steel – Used to clamp M21011 hose to M21050 fittings.



Hose Fitting, Female, Quick-Disconnect M21050P-3"

Connects to each end of M21011 hose using M21041 hose clamp



Ceiling Flange

M21061P

Black Polycarbonate fitting for room exhaust. Fits all ACS Hose Assemblies.



Ceiling Flange Cap

M21080

Quick-connect cap for ceiling flange or ceiling drop adapter.



Rack Simulator Cap

M21081

Quick-connect for ceiling flange or ceiling drop adapter to simulate the ventilation load of a rack and maintain air balance.



Ceiling Drop Adapter

M21090

Black PVC fitting for 3" duct room exhaust. Adapter fits all ACS Hose Assemblies.



Other Ventilation Accessories

M79230

4 x 3 Ceiling Drop Assembly

M79240

4" WYE Duct Assembly

M79235

6 x 3 Ceiling Drop Assembly

M79245

6" WYE Duct Assembly

M79264

Universal Exhaust Box Assembly

The Universal Exhaust Box Assembly is a space-saving, aesthetic alternative to Wye ducts or Tee ducts when installing ACS racks and connecting to ventilation. Installs close to ceiling and is ideal for low-headroom situations. Provides 4 exhaust hose connections to enable ventilation of two racks from one ceiling fitting. Installs quickly to either 4" or 6" animal room ceiling drops. Order M79244 for 4" Exhaust Box Assembly.



M79260

Exhaust Adapter Plate

This adapter plate is custom-designed to fit your ventilation requirements in any animal room with an exhaust grille. Typical plate shown.



Other custom ventilation fillings are available to solve any ventilation situation.

Opti only

Opti Exhaust Grid

C40520

Tailors exhaust air through rack's exhaust flange. Used with C79351 Rack Status Monitor.

Animal Care Systems, Inc. Product Catalog | 2012

OptiRAT® Parts

Opti Bottle Cap

C40150

Cap is a one-piece, stainless steel bottle cap designed to use with OptiMICE® Bottle.



Opti Ergonomic Bottle Cap Removal Tool Assembly

C79190

Tool is made of stainless steel with a soft rubber handle. One tool included per four OptiMICE® racks.



ACS Cage Card

M52010

Card is placed in integral card holder at front of cage. Cage Card is printed on front and back. Available in five colors for visual coding: white, red, blue, green, and yellow. Card Dimensions: 3" X 5".



OptiRAT Feeder

C40401

Standard feeder for OptiRAT cage. Made of polished stainless steel. Capacity: 37 ounces (1.1L).



C40420

OptiRAT Filter Flange – Front

C40421

Opti RAT Filter Flange – Back



Filter Flange - Front



Filter Flange - Back

C43240

OptiRAT Filter

C79570

OptiRAT Replacement Filter Kit – Includes 4 C43240 filters and 4 mounting screws



M.I.C.E.® Single-Sided Racks



M85010S1
14-Cage Rack Assembly



M85010S2
28-Cage Rack Assembly



M85010S3
42-Cage Rack Assembly



M85010S4
56-Cage Rack Assembly



M85010S5
70-Cage Rack Assembly

Polycarbonate, single-sided rack assemblies with mouse cages shown on this page.

All rack assemblies are sold complete.

Included: Cage assemblies, shelves, casters, exhaust manifolds and exhaust hoses (not shown)

The M.I.C.E.[®] System

Microenvironmental Comfort, Isolation, Containment, Enrichment

The original M.I.C.E. System is a modular, high-density vented caging system for healthy housing of rodents. These systems are available in a wide variety of sizes, from the smallest 14-cage system, ideal for small studies and experiments, to large 140-cage racks suitable for installation in medium-to-large animal rooms. Each size of rack is based on multiples of the 14-cage module. M.I.C.E. caging systems are sold in both single-sided and double-sided versions. The M.I.C.E. system is the only rodent caging system in the world validated for Microenvironmental comfort, Isolation, Containment, and Enrichment (M.I.C.E.). The M.I.C.E. rack is vented using a building's HVAC exhaust system, with a natural convective assist from the populated cages themselves. With no blowers, it is appropriate and safe even in case of power failure -- a unique feature that separates the vented M.I.C.E. system from electrically powered and blower-ventilated racks.

M.I.C.E. System:

Part Numbers Preceded By "M" are Clear Polycarbonate

Part Numbers Preceded By "P" are Amber Polysulfone

The M.I.C.E. System is not available in Smoke Polysulfone

Water Supply:

Standard: Bottle Assembly

Options:

(Automatic watering is available with Edstrom Valve on Cage.)

Appendix A – Single-Sided Rack Footprints

Dimensions in
inches (mm)

Vent hose locations
shown on each rack
in blue

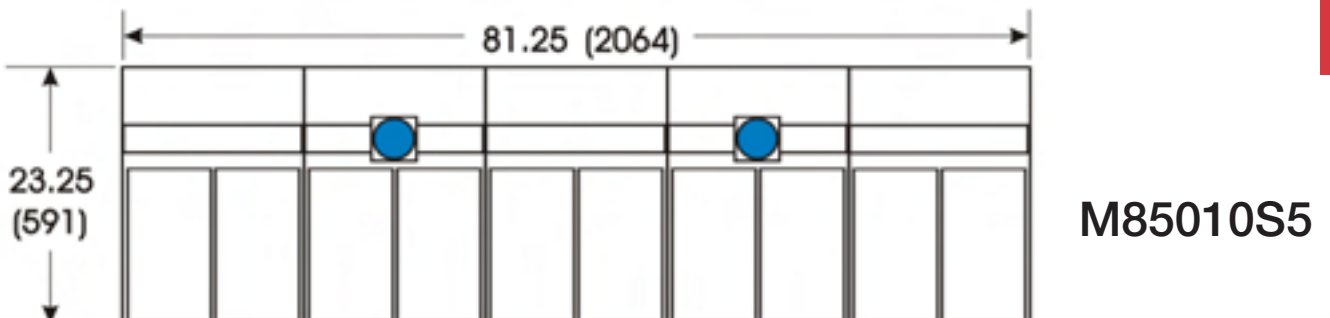
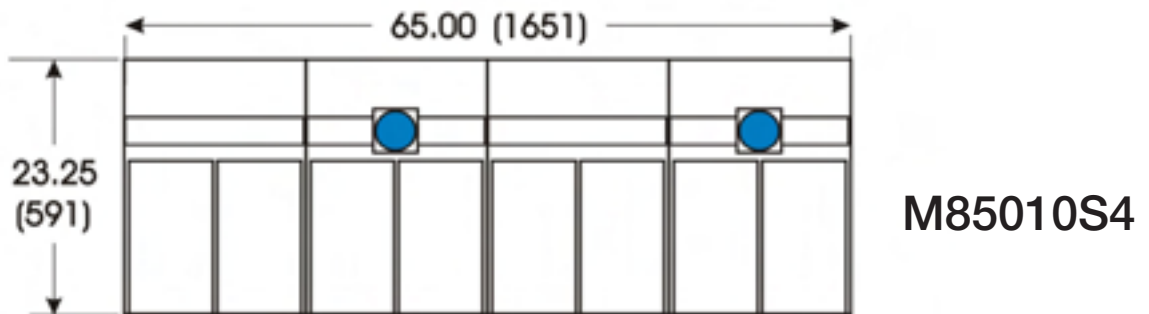
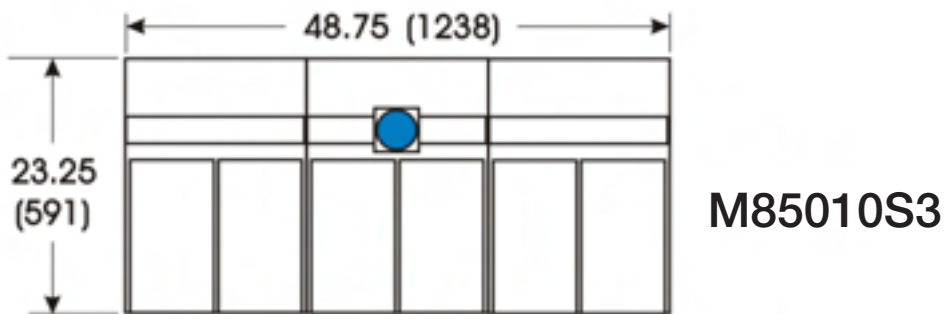
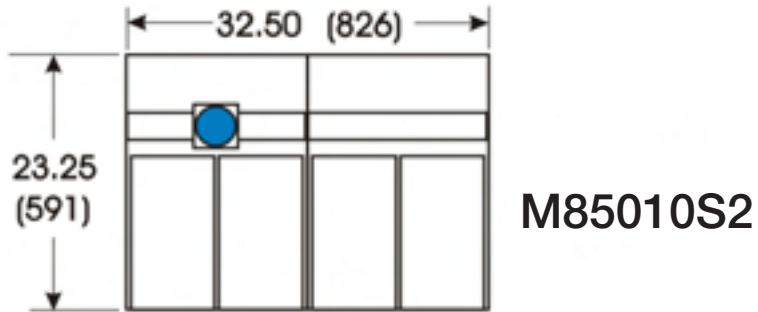
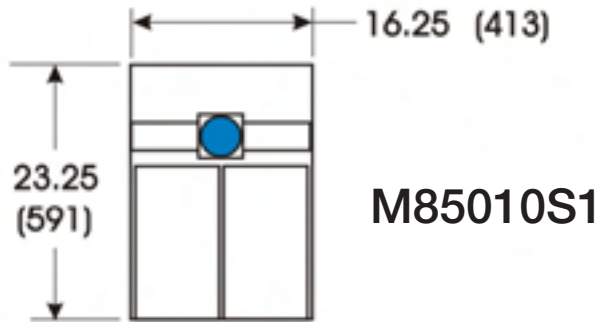

Animal Care Systems, Inc. Product Catalog | 2012

7086 South Revere Parkway, Centennial, Colorado 80112

Toll Free 888.827.3861 | Telephone 720.283.0177 | Fax 720.283.0179 | www.AnimalCareSystems.com

Appendix B – Double-Sided Rack Footprints

Dimensions in inches (mm)

Vent hose locations shown on each rack in blue

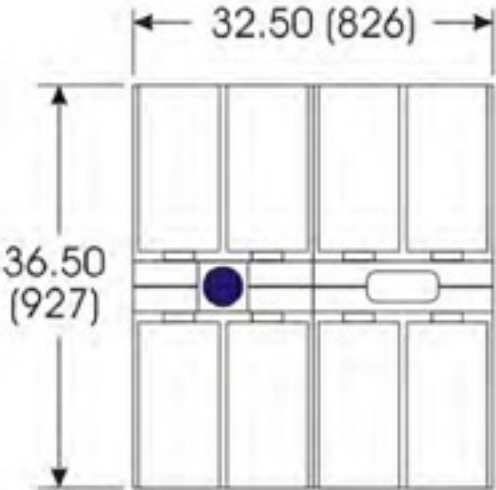

M85015D4
P85015D4

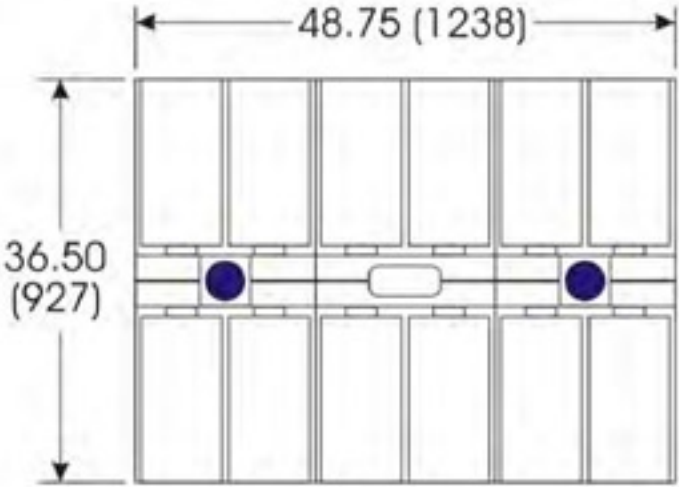

M85015D6
P85015D6

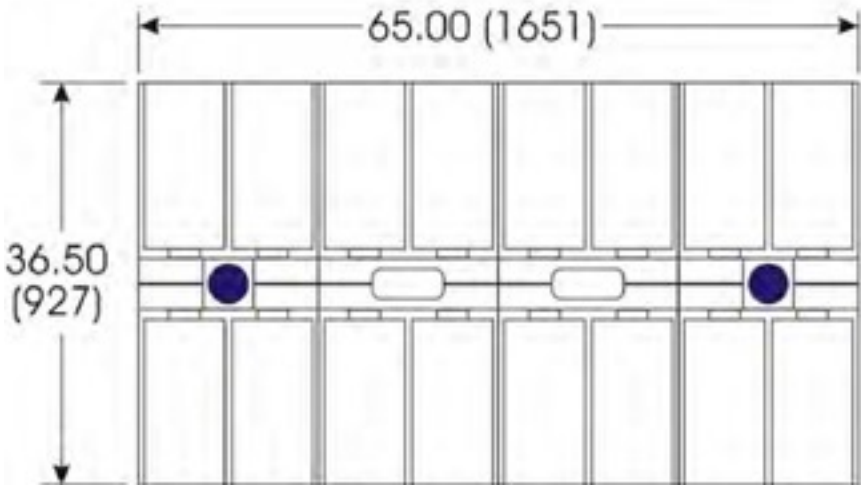

M85015D8
P85015D8

M.I.C.E.[®] Rack Assemblies With Mouse Cages, Single-Sided

14-Cage Rack Assembly, Clear Polycarbonate (M)/Amber Polysulfone (P)

M85010S1/P85010S1

Includes complete rack assembly with shelves, legs, casters and 14 mouse cage assemblies. 16.25" L x 23.25" D x 75.5" H, 150 pounds, including cages (413 mm L x 591 mm D x 1918 mm H, 68 kg).

28-Cage Rack Assembly, Clear Polycarbonate (M)/ Amber Polysulfone (P)

M85010S2/P85010S2

Includes complete rack assembly with shelves, legs, casters and 28 mouse cage assemblies. 32.5" L x 23.25" D x 75.5" H, 290 pounds, including cages (826 mm L x 591 mm D x 1918 mm H 132 kg).

42-Cage Rack Assembly, Clear Polycarbonate (M)/Amber Polysulfone (P)

M85010S3/P85010S3

Includes complete rack assembly with shelves, legs, casters and 42-mouse cage assemblies. 48.75" L x 23.25" D x 75.5" H, 431 pounds, including cages (1238 mm L x 591 mm D x 1918 mm H, 196 kg).

56-Cage Rack Assembly, Clear Polycarbonate (M)/Amber Polysulfone (P)

M85010S4/P85010S4

Includes complete rack assembly with shelves, legs, casters and 56 mouse cage assemblies. 65.0" L x 23.25" D x 75.5" H, 579 pounds, including cages (1651 mm L x 591 mm D x 1918 mm H, 263 kg).

70-Cage Rack Assembly, Clear Polycarbonate (M)/Amber Polysulfone (P)

M85010S5/P85010S5

Includes complete rack assembly with shelves, legs, casters and 70 mouse cage assemblies. 81.25" L x 23.25" D x 75.5" H, 722 pounds, including cages (2064 mm L x 591 mm D x 1918 mm H, 328 kg).



M85010S1



M85010S2



M85010S3



M85010S4



M85010S5

M.I.C.E.[®] Rack Assemblies

With Mouse Cages, Double-Sided

56-Cage Rack Assembly, Clear Polycarbonate (M)/Amber Polysulfone (P)

M85015D4/P85015D4

Includes complete rack assembly with shelves, legs, casters and 56 mouse cage assemblies. 32.5" L x 36.5" D x 75.5" H, 553 pounds, includes cages (826 mm L x 927 mm D x 1918 mm H, 251 kg).

84-Cage Rack Assembly, Clear Polycarbonate (M)/Amber Polysulfone (P)

M85015D6/P85015D6

Includes complete rack assembly with shelves, legs, casters and 84 mouse cage assemblies. 48.75" L x 36.5" D x 77.5" H, 869 pounds, includes cages (1238 mm L x 927 mm D x 1969 mm H, 395 kg).

112-Cage Rack Assembly, Clear Polycarbonate (M)/Amber Polysulfone (P)

M85015D8/P85015D8

Includes complete rack assembly with shelves, legs, casters and 112 mouse cage assemblies. 65.0" L x 36.5" D x 77.5" H, 1141 pounds, includes cages (1651 mm L x 927 mm D x 1969 mm H, 519 kg).

140-Cage Rack Assembly, Clear Polycarbonate (M)/Amber Polysulfone (P)

M85015D10/P85015D10

Includes complete rack assembly with shelves, legs, casters and 140 mouse cage assemblies. 81.25" L x 36.5" D x 77.5" H, 1412 pounds, includes cages (2064 mm L x 927 mm D x 1969 mm H, 642 kg).



M85015D8 112-Cage Rack Assembly

Animal Care Systems, Inc. Product Catalog | 2012

7086 South Revere Parkway, Centennial, Colorado 80112

Toll Free 888.827.3861 | Telephone 720.283.0177 | Fax 720.283.0179 | www.AnimalCareSystems.com

M.I.C.E.[®] Rack Assemblies With Rat Cages, Single-Sided

7-Cage Rack Assembly, Clear Polycarbonate (M)/Amber Polysulfone (P)

M85011S1/P85011S1

Includes complete rack assembly with shelves, legs, casters and 7 rat cage assemblies.
16.25" L x 23.25" D x 75.5" H, 150 pounds, includes cages (413 mm x 591 mm x 1918 mm, 68kg).

14-Cage Rack Assembly, Clear Polycarbonate (M)/Amber Polysulfone (P)

M85011S2/P85011S2

Includes complete rack assembly with shelves, legs, casters and 14 rat cage assemblies.
32.5" L x 23.25" D x 75.5" H, 290 pounds, includes cages (826 mm x 591 mm x 1918 mm, 132 kg).

21-Cage Rack Assembly, Clear Polycarbonate (M)/Amber Polysulfone (P)

M85011S3/P85011S3

Includes complete rack assembly with shelves, legs, casters and 21 rat cage assemblies.
48.75" L x 23.25" D x 75.5" H, 431 pounds, includes cages (1238 mm x 591 mm x 1918 mm, 196 kg).

28-Cage Rack Assembly, Clear Polycarbonate (M)/Amber Polysulfone (P)

M85011S4/P85011S4

Includes complete rack assembly with shelves, legs, casters and 28 rat cage assemblies.
65.0"L x 23.25" D x 75.5" H, 579 lbs, includes cages (1651 mm x 591 mm x 1918 mm, 263 kg).

35-Cage Rack Assembly, Clear Polycarbonate (M)/Amber Polysulfone (P)

M85011S5/P85011S5

Includes complete rack assembly with shelves, legs, casters and 35 rat cage assemblies.
81.25" L x 23.25" D x 75.5" H, 722 pounds, includes cages (2064 mm L x 591 mm x 1918 mm, 328 kg).

M.I.C.E.[®] Rack Assemblies

With Rat Cages, Double-Sided

28-Cage Rack Assembly, Clear Polycarbonate (M)/Amber Polysulfone (P)

M85016D4/P85016D4

Includes complete rack assembly with shelves, legs, casters and 28 rat cage assemblies. 32.5" L x 36.5" D x 75.5" H, 553 pounds, includes cages (826 mm x 927 mm D 1918 mm H 251 kg)

42-Cage Rack Assembly, Clear Polycarbonate (M)/Amber Polysulfone (P)

M85016D6/P85016D6

Includes complete rack assembly with shelves, legs, casters and 42 rat cage assemblies. 48.75" L x 36.5" D x 77.5" H, 869 pounds, includes cages (1238 mm x 927 mm x 1969 mm, 395 kg)

56-Cage Rack Assembly, Clear Polycarbonate (M)/Amber Polysulfone (P)

M85016D8/P85016D8

Includes complete rack assembly with shelves, legs, casters and 56 rat cage assemblies. 65.0" L x 36.5" D x 77.5" H, 1141 pounds, includes cages (1651 mm x 927 mm x 1969 mm, 519 kg)

70-Cage Rack Assembly, Clear Polycarbonate (M)/Amber Polysulfone (P)

M85016D10/P85016D10

Includes complete rack assembly with shelves, legs, casters and 70 rat cage assemblies. 81.25" L x 36.5" D x 77.5" H, 1412 pounds, includes cages (2064 mm x 927 mm x 1969 mm, 642 kg)

M.I.C.E.[®] System

Mouse Rack Automatic Watering Options

M.I.C.E. Edstrom Automatic Watering Assembly
Not available with M85010S1

| | |
|------------|----------------|
| M45010S2A | Fits M85010S2 |
| M45010S3A | Fits M85010S3 |
| M45010S4A | Fits M85010S4 |
| M45010S5A | Fits M85010S5 |
| M45010D4A | Fits M85010D4 |
| M45010D6A | Fits M85010D6 |
| M45010D8A | Fits M85010D8 |
| M45010D10A | Fits M85010D10 |

Order with M80110 or P80110 Cages, Type 1 Interface, with Automatic Watering, for cages sold prior to September 2003. Order with M80110A or P80110A Cages, Type 2 Interface, with Automatic Watering for cages sold after September 2003.

M.I.C.E.[®] System

Rat Rack Automatic Watering Options

Not available with M85011S1

| | |
|------------|----------------|
| M45011S2A | Fits M85011S2 |
| M45011S3A | Fits M85011S3 |
| M45011S4A | Fits M85011S4 |
| M45011S5A | Fits M85011S5 |
| M45011D4A | Fits M85011D4 |
| M45011D6A | Fits M85011D6 |
| M45011D8A | Fits M85011D8 |
| M45011D10A | Fits M85011D10 |

Order with M80131 or P80131 Cages Equipped for Automatic Watering



View of 70-cage rack adapted for automatic watering. Some cages removed for clarity.



M.I.C.E. cage adapted to automatic watering.



Close-up of cage installed on automatic watering rack.

Animal Care Systems, Inc. Product Catalog | 2012

7086 South Revere Parkway, Centennial, Colorado 80112
Toll Free 888.827.3861 | Telephone 720.283.0177 | Fax 720.283.0179 | www.AnimalCareSystems.com

M.I.C.E.® System

Automatic Watering Accessories

Sipper Tube Closure – Type 1 Cage top only

M79281

The Sipper Closure for the M.I.C.E. Type 1 cage top securely closes the oval bottle sipper tube port in the cage top. Consists of a high-temperature black polymer closure secured with a knurled stainless steel thumb screw for simple installation without tools.



Sipper Closure – Type 2 Cage top only

M79280

304 Stainless Steel and high-temperature plastic. Seals the bottle sipper tube opening when using automatic watering, when the water bottle is removed or when moving sterile cage assembly in non-sterile environment.



Water Valve Cap Assembly

M45080A

304 Stainless Steel. Covers watering valve and allows selective cages to be isolated from automatic watering system when using a water bottle. Easy push-on design. Fits all Edstrom cage-mounted valves on both M.I.C.E. and Opti systems.



Edstrom Watering Valve

M45050

Mounted on cage, this valve engages the watering QD on M.I.C.E System racks. 316 stainless steel components with high-temperature polymer seals.



Customers who order M.I.C.E. System racks also purchase:

Water Bottle Basket

M61011

Stainless steel water basket holds 24 400 ml water bottles in 6 x 4 arrays. Height and locking mechanism hold bottles in place when inverted.



Complete Change-out Cage Assemblies

See page 66

Anemometer Assembly

M79210

Accurately measures the air velocity through an exhaust hose.



Mouse Cage Tox Floor

M40010

Drop-in raised floor for bedding-free housing. Allows for collection of fecal material and accommodates M40022C feeder in integral drop-in basket.

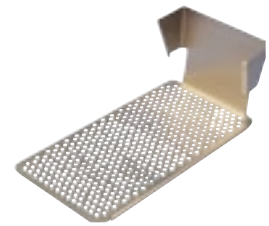

Large Hole Tox Floor

M40011

Same as above, for rat cage.



Rat Cage Tox Floor

M40012

Drop-in raised floor for bedding-free housing. Allows for collection of fecal material.



Universal Ventilation Parts

Universal Ventilation Parts for all ACS racks — OptiMICE/ErgoMICE, OptiRAT and M.I.C.E.

A Flex Hose Assembly can replace worn or damaged existing hose assemblies, or is used to provide additional ventilation to large M.I.C.E. System rack assemblies installed in rooms with marginal ventilation.

Hi-temp Exhaust Hose Assembly

M79H06 Flex Hose Assembly - Standard 6-Foot Extended Length
Includes 3" diameter hose, two M21041 hose clamps and two M21050 female hose fittings.



Optional High-temp Exhaust Hose Assembly

M79H02 through M79H25

Last two digits indicate hose length. Available in 1-foot increments, from 2' through 10', 12', 15', 20' and 25'.

M21120 3" Hi-Temp Hose. Priced per foot.



Lightweight Flex Hose Assembly

M79056P Optional 5' short length
M79055P Standard 10' length
M79051P Optional 15' extended length
M79052P Optional 20' extended length



Lightweight Flex Hose Only

M21011 Flexible 3" diameter exhaust hose. Priced per foot, maximum of 20'.

Damper

M79190
Controls airflow from a rack exhaust hose. Fits all Animal Care Systems racks.
Flange not included.



Stainless Steel Hose Clamp

M21041-3"

3" Stainless Steel – Used to clamp M21011 hose to M21050 fittings.



Animal Care Systems, Inc. Product Catalog | 2012

7086 South Revere Parkway, Centennial, Colorado 80112

**Hose Fitting, Female, Quick-Disconnect
M21050P-3"**

Connects to each end of M21011 hose using M21041 hose clamp



Ceiling Flange

M21061P

Black Polycarbonate fitting for room exhaust. Fits all ACS Hose Assemblies.



Ceiling Flange Cap

M21080

Quick-connect cap for ceiling flange or ceiling drop adapter.



Rack Simulator Cap

M21081

Quick-connect for ceiling flange or ceiling drop adapter to simulate the ventilation load of a rack and maintain air balance.



Ceiling Drop Adapter

M21090

Black PVC fitting for 3" duct room exhaust. Adapter fits all ACS Hose Assemblies.



Other Ventilation Accessories

M79230

4 x 3 Ceiling Drop Assembly

M79240

4" WYE Duct Assembly

M79235

6 x 3 Ceiling Drop Assembly

M79245

6" WYE Duct Assembly

M79264

Universal Exhaust Box Assembly

The Universal Exhaust Box Assembly is a space-saving, aesthetic alternative to Wye ducts or Tee ducts when installing ACS racks and connecting to ventilation. Installs close to ceiling and is ideal for low-headroom situations. Provides 4 exhaust hose connections to enable ventilation of two racks from one ceiling fitting. Installs quickly to either 4" or 6" animal room ceiling drops. Order M79244 for 4" Exhaust Box Assembly.



M79260

Exhaust Adapter Plate

This adapter plate is custom-designed to fit your ventilation requirements in any animal room with an exhaust grille. Typical plate shown.



Other custom ventilation fillings are available to solve any ventilation situation.

Opti only

Opti Exhaust Grid

C40520

Tailors exhaust air through rack's exhaust flange. Used with C79351 Rack Status Monitor.

Animal Care Systems, Inc. Product Catalog | 2012

7086 South Revere Parkway, Centennial, Colorado 80112

Toll Free 888.827.3861 | Telephone 720.283.0177 | Fax 720.283.0179 | www.AnimalCareSystems.com

M.I.C.E.[®] System

Mouse Cage Assemblies

Mouse Cage Assembly, Type I, Clear Polycarbonate (M)/Amber Polysulfone (P)

M80100/ P80100

Includes the following:

- | | |
|---------------------------|---|
| M79010/ P79010 | Mouse Cage Bottom Assembly |
| M79020/ P79020 | Mouse Cage Top Assembly, Type 1 Interface |
| MR79030A/ PR79030A | Round Bottle Assembly, Type 1 Interface |
| M52010 | Cage Card |



Mouse Cage Assembly, Type II, Clear Polycarbonate (M)/Amber Polysulfone (P)

M80100A/ P80100A

Includes the following:

- | | |
|--------------------------|---|
| M79010/ P79010 | Mouse Cage Bottom Assembly |
| M79021/ P79021 | Mouse Cage Top Assembly, Type 2 Interface |
| MR79030B/ P79030B | Round Bottle Assembly, Type 2 Interface |
| M52010 | Cage Card |



Mouse Cage Assembly, Type I, Clear Polycarbonate (M)/Amber Polysulfone (P) with Automatic Watering Valve

M80110/ P80110

Includes the following:

- | | |
|-----------------------|---|
| M79011/ P79011 | Mouse Cage Bottom Assembly |
| M79020/ P79020 | Mouse Cage Top Assembly, Type 1 Interface |
| M52010 | Cage Card |

Mouse Cage Assembly, Type II, Clear Polycarbonate (M)/Amber Polysulfone (P) with Automatic Watering Valve

M80110A/P80110A

Includes the following:

- | | |
|-----------------------|---|
| M79011/ P79011 | Mouse Cage Bottom Assembly |
| M79021/ P79021 | Mouse Cage Top Assembly, Type 2 Interface |
| M52010 | Cage Card |

- | | |
|----------------|--|
| MP79012 | Mouse Cage Bottom Assembly for Watering (no valve) |
|----------------|--|

Animal Care Systems, Inc. Product Catalog | 2012

7086 South Revere Parkway, Centennial, Colorado 80112

M.I.C.E.® System

Rat Cage Assemblies

Rat Cage Assembly, Clear Polycarbonate (M)/Amber Polysulfone (P)
M80121/ P80121



Rat Cage Assembly, Clear Polycarbonate (M)/Amber Polysulfone (P), with Automatic Watering Valve
M80131/ P80131

MP79127

Rat Cage Bottom Assembly for Watering (no valve)

M.I.C.E.® System Cage Sub-Assemblies

Mouse Cage Bottom Assembly, Clear Polycarbonate (M)/Amber Polysulfone (P)

M79010/P79010

Includes: Cage Bottom, Filter Assemblies & Exhaust Nozzle



Mouse Cage Bottom Assembly, Clear Polycarbonate (M)/Amber Polysulfone (P), with Automatic Watering Valve

M79011/P79011

Includes: Cage Bottom, Filter Assemblies & Exhaust Nozzle, Grommet, Drinking Valve



Mouse Cage Top Assembly, Clear Polycarbonate (M)/Amber Polysulfone (P), Type 1 Interface

M79020/P79020

Includes: Feeder, Feeder Lid and Cage Card



Mouse Cage Top Assembly, Clear Polycarbonate (M)/Amber Polysulfone (P), Type 2 Interface

M79021/P79021

Includes: Feeder, Feeder Lid and Cage Card



Rat Cage Bottom Assembly, Clear Polycarbonate (M)/Amber Polysulfone (P)

M79121/P79121

Includes: Wire Rat Feeder, Filter Assemblies & Exhaust Nozzles



Rat Cage Top, Clear Polycarbonate (M)/Amber Polysulfone (P)

M43026/P43026



Round Bottle Assembly, Clear Polycarbonate (M)/Amber Polysulfone (P), Type 1 Interface

MR79030A/PR79030A

Includes: 14 oz/400 ml. Polycarbonate Bottle/Seal Assembly, Bottle Cap Assembly.

Dimensions: 7.5" Long x 2.45" diameter.



Round Bottle Assembly, Clear Polycarbonate (M)/Amber Polysulfone (P), Type 2 Interface

MR79030B/PR79030B

Includes: 14 oz/400 ml. Polycarbonate Bottle/Seal Assembly, Bottle Cap Assembly.

Dimensions: 7.5" Long x 2.45" diameter.



Round Bottle/Seal Sub-Assembly, Clear Polycarbonate (M)/Amber Polysulfone (P)

M79031A/P79031A

Includes: Round Water Bottle & Water Bottle Seal only.



Bottle Cap Assembly, Radel R Black, Type 1 Interface

R79035

Bottle cap assembly with 4.0" sipper tube

R79038

Bottle cap assembly with 2.5" sipper tube (not shown)



Bottle Cap Assembly, Radel R Black, Type 2 Interface

R79036 Bottle cap assembly with 4.0" sipper tube (not shown)

R79039 Bottle cap assembly with 2.5" sipper tube



Round Bottle Assembly

P79100 BLK, Type 1 Interface (not shown)

P79101 BLK, Type 2 Interface



Rat Cage Bottle Assembly, Clear Polycarbonate (M)/Amber Polysulfone (P), long sipper tube

MR79038/PR79038

21 oz/600 ml Bottle, cap is a taper fit to the bottle with soft ribbed seal.

Includes:

M79037/P79037 Rat Bottle/Seal Sub-Assembly

R79036 Bottle Cap Assembly



Rat Cage Bottle Assembly, Clear Polycarbonate (M)/Amber Polysulfone (P), short sipper tube

MR79038A

21 oz/600 ml Bottle, cap is a taper fit to the bottle with soft ribbed seal

Includes:

M79037/P79037 Rat Bottle/Seal sub-assembly

R79039 Bottle Cap Assembly



Rat Bottle/Seal Sub-Assembly, Clear Polycarbonate (M)/Amber Polysulfone (P)

M79037/P79037

M51030/P51030 Rat Cage Water Bottle

M41070 Water Bottle Seal



The Original M.I.C.E. System

M.I.C.E.® System

Optional Accessories

The **M72010 Module Joining Kit** includes all the hardware and parts needed to join two modules together into a single unit. For instance, four S1 racks are easily reconfigured into one S4 rack by using three M72010 kits. Each kit includes detailed attachment instructions.

When joining modules into the three largest double-sized racks, the M79110 Caster Adapter Kit provides the additional strength needed to support the increased weight. It includes four larger casters, reinforcing plates and all the hardware needed to install. Order one kit for each D6, D8 or D10 rack. For instance, if you join two D4 racks into one D8 rack, the M79110 is needed.

Cage Clip

M43080

Two pure nylon clips secure the cage top in place for transport. Cage Clips are sold individually.



Inhalation Nozzle Assembly

M43090

Inserts into cage air inlet port to allow introduction of gas to individual cages.



Tox Floor, Mouse Cage

M40010

Drop-in raised floor for bedding-free housing. Allows for collection of fecal material and accommodates M40022C feeder in integral drop-in basket.

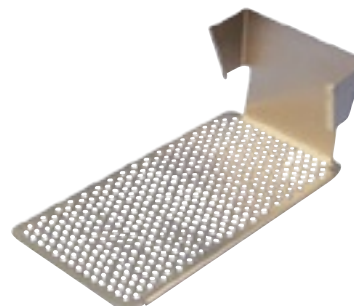

Large Hole Tox Floor, Mouse Cage

M40011

Stainless Steel floor for use with rats in standard mouse cage (M80100 & P80100).
Accommodates M40022C feeder in integral drop-in basket.

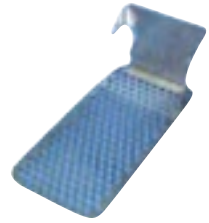

Rat Cage Tox Floor

M40012

Stainless Steel floor for use in rat cage assemblies (M80121 and P80121).

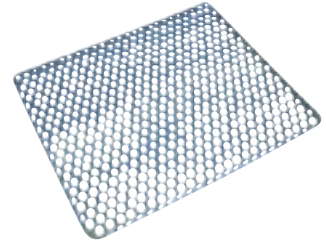

Large Capacity Rat Feeder, Mouse Cage

M40023

Unique inverted vee-shaped feeder with 40% greater capacity than mouse feeder.
Dimensions: 6.25"L x 3.2"W x 4.25"H. Install in mouse cage for single-housed rats.



Rat/Guinea Pig J-Feeder

M40028

Replace our standard rat feeder with a J-Type feeder if you need to provide either powder or granular feed. Connects to the same point in the rat cage as the standard feeder. Made from polished stainless steel.



Black Bottle Assemblies

- P79100 Black Bottle Assembly, Type 1 Interface (not shown)
- P79101 Black Bottle Assembly, Type 2 Interface
- P79031BLK Black Bottle Seal Sub-Assembly



Mouse Bottle Basket

M61011

Stainless steel water basket holds 24 400 ml water bottles in 6 x 4 arrays. Height and locking mechanism hold bottles in place when inverted.



Rat Bottle Basket

M61012

Stainless steel water basket holds 20 rat water bottles in 5 x 4 arrays. Height and locking mechanism hold bottles in place when inverted.



M48101 Optional Cover Available

Animal Care Systems, Inc. Product Catalog | 2012

7086 South Revere Parkway, Centennial, Colorado 80112

Toll Free 888.827.3861 | Telephone 720.283.0177 | Fax 720.283.0179 | www.AnimalCareSystems.com

Universal Accessories

Opti Rack Status Monitor

C79351

ACS Rack Status Monitor is a totally solid-state unit that mounts on any Opti rack and displays the rack airflow in CFM. With no moving parts, it has no spinning impellers that can wear out bearings or fly apart. Installation is a simple matter of mounting the quick-disconnect sending unit in line with one of the exhaust hoses, hanging the display unit at the top of the rack, connecting the USB cable between them, and turning on the unit. Like the racks themselves, the RSM needs no external supply of electricity. Its six AA-sized lithium batteries provide power for many months of 24/7 rack monitoring without replacement.



Universal Anemometer Assembly

M79210

Accurately samples the air velocity through an exhaust hose, providing a spot-checking capability for rack exhaust.



ACS Bulk Cart

C79345

Animal Care Systems' transport/storage cart is designed for moving large numbers of our cages at once, but can easily transport other bulk loads. With an all-stainless steel, welded construction and high-temperature, 5-inch casters, it is autoclavable and sturdy enough for long-term, severe service. At 72" long and 31" deep, the completely open side allows for easy loading of up to 400 OptiMICE cages or 128 OptiRAT cages. The cart floor is slightly inclined inwards to further stabilize tall cage stacks. Weight is 175 pounds.



Fail-safe Fan

C80010

Mounts directly on an Opti rack to one hose fitting and can provide emergency rack ventilation for up to 72 hours if animal room ventilation is not available. When used, the other hose fitting is capped. It features a quiet brushless fan powered by three conventional 12-volt drill batteries (included). Batteries are easily removed for charging in the included battery charger.



Fail-safe Battery Charger

C48050

Clean Aire – Double

M83011

Replaces HVAC – for two-hose connection. Includes pre-filter, micro HEPA filter, and 15 pounds (6.8 Kg) of replaceable activated carbon. The Clean Aire features a 400-watt, three-speed motor. It is a quiet, free-standing unit that uses the same hose and coupling system as all ACS equipment. It can quickly be added to any rack to draw room air through the rack when room exhaust is not available.



M83020 Clean Aire HEPA Filter

M83030 Clean Aire Carbon Filter

M83040 Clean Aire Pre-Filter (4-pack)

Replaceable, internal filter.

Bedding Scoop

M65040

Bedding scoop ensures the correct amount of bedding. Two full scoops provide perfect bedding depth in OptiRAT cages.



Enrichment

Trough Tunnel

M43040

Pure nylon enrichment device for the animal. Small rodents can hide underneath; it also provides an item for chewing urges.



M.I.C.E.® System Parts

Single Top Cover Assembly

M79060

Assembly includes the following: M40280 – Single Top Cover, M41030 – Top Cover Gasket, pre-assembled attachment hardware.

Does not include module plug.



When using additional hoses to supplement rack ventilation, order the M79080 Single Manifold Assembly for single rack configurations, or the M79090 Double Manifold Assembly for double rack configurations. Both mount directly to module top covers with the included nylon fasteners. No tools are required.

Single Manifold Assembly

M79080

Includes the following: M40230 – Single Manifold, M41010 – Module Gasket, M21060 – Manifold Flange, 4 each M30080 – ½” nylon screw, 2 each M30090 – ¾” nylon screw.

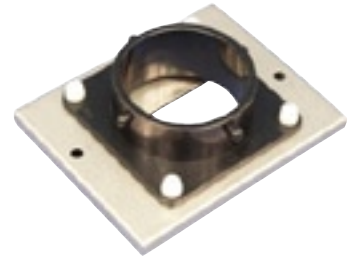

Double Manifold Assmby

M79090

Includes the following: M40240 – Double Manifold, 2 each M41010 – Module Gasket, M21060 – Manifold Flange, 4 each M30080 – ½” nylon screw, 2 each M30090 – ¾”

nylon screw.



Double Top Cover Assembly

M79070

Includes the following: M40290 – Double Top Cover, 2 each M41030 – Top Cover Gasket. Assembly is pre-assembled attachment hardware.

Does not include module plug.



Cage Shelf

M40300A

Supports two mouse cages or one rat cage interchangeably.

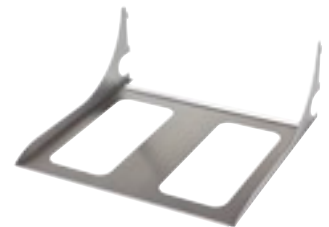

Rack Handle

M40250A

Fits all M.I.C.E. System racks.



Module Plug

M41020

Plugs open connecting vents on modules of rack assemblies and unused top cover ventilation ports. Made of EPDM rubber.



Top Cover Gasket

M41030

Seals module top cover to each module. EPDM closed-cell foam with PSA backing.



Mouse Cage Top, Clear Polycarbonate (M) /Amber Polysulfone (P), Type 1 Interface

M43020/P43020

Cage Top only — Does not include feeder, feeder lid or cage card.

Dimensions: 15.3" L x 7.8" W x 3.6" H



Mouse Cage Top, Clear Polycarbonate (M) /Amber Polysulfone (P), Type 2 Interface

M43021/P43021

Cage Top only — Does not include feeder, feeder lid or cage card.

Dimensions: 15.3" L x 7.8" W x 3.6" H



Rat Cage Top, Clear Polycarbonate (M) /Amber Polysulfone (P)

M43026/P43026

Cage Top only — Does not include water bottle or cage card.

Dimensions: 15.3" L x 15.9" W x 3.6" H



Screen, Stainless Steel, 16 Mesh

M40060

Secures and protects the polyester media filters at both ends of cage. Used on the outside, away from the animals. Oval, 2.7" W x 1.8" H.

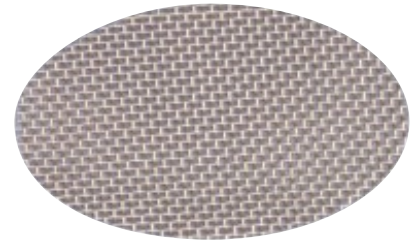

Screen, Stainless Steel, 40 Mesh

M40050

Protects the polyester media filters at both ends of cage. Used on the inside, next to the animals. Oval, 2.7" W x 1.8" H.



Rat Cage Dished Screen, Stainless Steel, 40 Mesh

M40052

Screen protects the filter and cage opening at both ends of cage. Used on the inside of rat cages, next to the animals.



Cage Filter

M40040

Filters the air, both incoming and outgoing. Oval, 2.7" W x 1.8" H.



Filter Spring Clip

M40130

Clip retains the filter assembly securely in the cage air inlet.



Exhaust Nozzle, Clear Polycarbonate (M)/Amber Polysulfone (P)

M43060/P43060

Holds rear exhaust filter unit in place. Connects cage to plenum and provides air passage.

Dimensions: 3.0" W x 2.0" H x 2.25" L



Feeder Lid, Clear Polycarbonate (M)/ Amber Polysulfone (P)

M43051/P43051

Covers the external feeder opening on mouse cages.

Dimensions: 6.7" W x 3.8" H x .4" L



Water Bottle Seal

M41070

Ribbed, silicone bottle seal ensures leak-free bottle performance.

Fits all M.I.C.E. System water bottles.



Cage Card

M52010

Placed in an integral card holder at front of cage top. Card Dimension: 3" L x 5" H.

Available in five colors for visual coding: White, Red, Blue, Green, Yellow



Wire Mouse Feeder

M40022C

Vee-shaped, electropolished stainless steel wire mouse feeder.

Dimensions: 6.25"L x 3.2"W x 6.1"H. Feeder fits in mouse cage only.

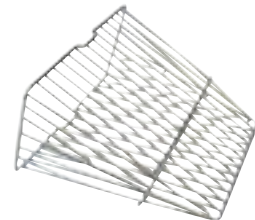

Wire Mouse/Rat Feeder

M40026B

Vee-shaped, electropolished stainless steel wire mouse/rat feeder.

Feeder fits in rat cage only.

Dimensions: 6.6" L x 3.3" W x 6.6" H

Capacity: 1,000 grams (1 liter)



Technical Specifications

Recommended Airflow Measurements For OptiMICE®, ErgoMICE®, OptiRAT®, and M.I.C.E.® Racks

Each Animal Care Systems rack should be tested after installation to ensure that airflow through the rack meets or exceeds minimum flow requirements. Racks holding small rodents should achieve at least 15-20 Air Changes per Hour (ACH) after hookup to the animal room exhaust. 30 ACH will allow longer cage-changing periods and requires more airflow through the cages. Larger rodents such as rats and guinea pigs require higher airflows due to the greater evaporative transpiration from the animals. The tables below identify both the MINIMUM and the RECOMMENDED hose air velocity measurement for achieving good airflows in the M.I.C.E., OptiMICE, ErgoMICE, and OptiRAT racks. Minimum flows are equivalent to 15-20 ACH with mice cages. Recommended flows are approximately 25-30 ACH. M.I.C.E. rat racks and OptiRAT racks require higher minimum airflows due to increased cage volume and housed animal mass.

Airflow measurements noted in the tables below must be made with an M79210 ACS Anemometer to assure accuracy. Contact Animal Care Systems for assistance if an installation does not achieve the noted MINIMUM values noted in the table.

*Single-use

| OptiMICE / ErgoMICE / OptiRAT Rack Airflow Data | | | | | |
|---|----------------|---|---|---|---|
| Rack Size | Hoses Per Rack | MINIMUM Air Volume Needed From Rack Exhaust | MINIMUM Anemometer Measurement Per Hose | RECOMMENDED Air Volume Needed From Rack Exhaust | RECOMMENDED Anemometer Measurement Per Hose |
| OptiMICE – 100 Cage | 2 | 40 CFM *60 CFM | 3.5 m/s *5.25 m/s | 60 CFM *75 CFM | 5.25 m/s *6.6 m/s |
| ErgoMICE – 80 Cage | 2 | 34 CFM *51 CFM | 3.0 m/s *4.5 m/s | 51 CFM *64 CFM | 4.5 m/s *5.6 m/s |
| ErgoMICE – 70 Cage | 2 | 30 CFM *45 CFM | 2.6 m/s *3.9 m/s | 45 CFM *56 CFM | 3.9 m/s *4.9 m/s |
| ErgoMICE – 50 Cage | 1 | 22 CFM *33 CFM | 3.8 m/s *5.7 m/s | 33 CFM *41 CFM | 5.7 m/s *7.1 m/s |
| | | | | | |
| OptiRAT – 42 Cage | 2 | 55 CFM | 4.8 m/s | 82 CFM | 7.2 m/s |

Note 1: The 50-Cage ErgoMICE racks uses only one hose for ventilation. The other hose connection is capped with an M21080 Ceiling Flange Cap.

Note 2: Readings with asterisks are OptiMICE/ErgoMICE ventilation requirements when using ACS Single-use Cages.

M.I.C.E. Mouse Rack Airflow Data

| Rack Size | Hoses Per Rack | MINIMUM Air Volume Needed From Rack Exhaust | MINIMUM Anemometer Measurement Per Hose | RECOMMENDED Air Volume Needed From Rack Exhaust | RECOMMENDED Anemometer Measurement Per Hose |
|---------------|----------------|---|---|---|---|
| S1, 14-Cage | 1 | 8 CFM | 1.3 m/s | 12 CFM | 2.0 m/s |
| S2, 28-Cage | 1 | 16 CFM | 2.6 m/s | 24 CFM | 3.9 m/s |
| S3, 42-Cage | 1(2) | 24 CFM | 3.9 m/s | 36 CFM | 5.9 m/s |
| S4, 56-Cage | 2 | 32 CFM | 2.6 m/s | 48 CFM | 3.9 m/s |
| S5, 70-Cage | 2 | 40 CFM | 3.2 m/s | 60 CFM | 4.8 m/s |
| | | | | | |
| D4, 56-Cage | 2 | 32 CFM | 2.6 m/s | 48 CFM | 3.9 m/s |
| D6, 84-Cage | 2 | 48 CFM | 3.9 m/s | 72 CFM | 5.9 m/s |
| D8, 112-Cage | 2(3)* | 64 CFM | 5.2(3.5) m/s | 96 CFM | 7.8(5.25) m/s |
| D10, 140-Cage | 2(3)* | 80 CFM | 6.5(4.3) m/s | 120 CFM | 9.8(6.5) m/s |

*Some situations with less than ideal room ventilation may require three exhaust hoses on D8 112-Cage and D10 140-Cage racks

M.I.C.E. Rat Rack Airflow Data

| Rack Size | Hoses Per Rack | MINIMUM Air Volume Needed From Rack Exhaust | MINIMUM Anemometer Measurement Per Hose | RECOMMENDED Air Volume Needed From Rack Exhaust | RECOMMENDED Anemometer Measurement Per Hose |
|--------------|----------------|---|---|---|---|
| S1, 7-Cage | 1 | 12 CFM | 1.9 m/s | 18 CFM | 2.9 m/s |
| S2, 14-Cage | 1 | 24 CFM | 3.8 m/s | 36 CFM | 5.7 m/s |
| S3, 21-Cage | 1(2) | 36 CFM | 5.7(2.9) m/s | 54 CFM | 8.5(4.4) m/s |
| S4, 28-Cage | 2 | 48 CFM | 3.8 m/s | 72 CFM | 5.7 m/s |
| S5, 35-Cage | 2 | 60 CFM | 4.9 m/s | 90 CFM | 7.3 m/s |
| | | | | | |
| D4, 28-Cage | 2 | 48 CFM | 3.8 m/s | 72 CFM | 5.7 m/s |
| D6, 42-Cage | 2 | 72 CFM | 5.7 m/s | 108 CFM | 8.5 m/s |
| D8, 56-Cage | 2(3)** | 96 CFM | 7.8(5.2) m/s | 144 CFM | 11.7(7.8) m/s |
| D10, 70-Cage | 2(3)** | 120 CFM | 9.7(6.5) m/s | 180 CFM | 14.5(9.7) m/s |

*Some situations with less than ideal room ventilation may require three exhaust hoses on D8 112-Cage and D10 140-Cage racks

ACS Anemometer Reading to CFM Cross-Reference

| | | | | | | | | | |
|-----|------|------|------|-------|-------|-------|-------|-------|-------|
| M/S | 1.0 | 1.2 | 1.4 | 1.6 | 1.8 | 2.0 | 2.2 | 2.4 | 2.6 |
| CFM | 11.4 | 13.7 | 16.0 | 18.3 | 20.6 | 22.9 | 25.1 | 27.4 | 29.7 |
| | | | | | | | | | |
| M/S | 2.8 | 3.0 | 3.2 | 3.4 | 3.6 | 3.8 | 4.0 | 4.2 | 4.4 |
| CFM | 32.0 | 34.3 | 36.6 | 38.9 | 41.1 | 43.4 | 45.7 | 48.0 | 50.3 |
| | | | | | | | | | |
| M/S | 4.6 | 4.8 | 5.0 | 5.2 | 5.4 | 5.6 | 5.8 | 6.0 | 6.2 |
| CFM | 52.6 | 54.9 | 57.1 | 59.4 | 61.7 | 64.0 | 66.3 | 68.6 | 70.9 |
| | | | | | | | | | |
| M/S | 6.4 | 6.6 | 6.8 | 7.0 | 7.2 | 7.4 | 7.6 | 7.8 | 8.0 |
| CFM | 73.1 | 75.4 | 77.7 | 80.0 | 82.3 | 84.6 | 86.9 | 89.1 | 91.4 |
| | | | | | | | | | |
| M/S | 8.2 | 8.4 | 8.6 | 8.8 | 9.0 | 9.2 | 9.4 | 9.6 | 9.8 |
| CFM | 93.5 | 95.8 | 98.0 | 100.3 | 102.6 | 104.9 | 107.2 | 109.4 | 111.7 |

Note 1: Readings less than 1.0 M/S indicate less than adequate airflow in any ACS rack.

Note 2: Cross Reference shows rack CFM on racks with two hoses and M/S measurement performed on one of the hoses. For single-hose racks, divide the CFM in the chart by 2.

Animal Care Systems, Inc. Product Catalog | 2012

7086 South Revere Parkway, Centennial, Colorado 80112

OptiMICE Rack

The OptiMICE exhaust vented carousel caging system offers a unique means of rodent housing in the animal care industry. This system is unmatched in space-efficiency and its ability to house rodents in the best possible environmental conditions. The convection-assisted, low velocity, one-pass airflow through each cage provides animals with the gentle ventilation necessary to ensure maximum comfort in an ideal, low-stress living and breeding environment. With no motors or blowers, OptiMICE equipped rooms are virtually noise, vibration, and odor-free.

OptiMICE C89100 Rack Specifications

100-Cage Rack Assembly, Polycarbonate (also available in amber or clear polysulfone)

- Includes complete stainless steel rack assembly with reinforced polymer carousel, cages, casters, and 2 vent hose assemblies
- Includes 100 mouse cage assemblies with filters, feeders, cage cards, and water bottles
- Rack Dimensions/100 cages -- 39.5”L x 39.0”W x 77.0” H
- Rack Dimensions/60 cages -- 39.5”L x 33.5”W x 77.0” H (4 columns of cages removed for door clearance)
- Two vent hoses mount near top center of rack with quick-disconnect fittings
- 558 lbs complete and ready for installation
- Rack assembly is mounted on stainless steel casters with 4” diameter hi-temp wheels
Two casters are provided with brakes and locks
- Air flow requirements – 60 CFM recommended, 40 CFM minimum per rack
- Full-height handles
- Pleated high-flow Reemay filter assemblies with integral faceplates

| Cage Specific Information |
|--|
| Mouse Cage |
| Outside dims – 13.5” Lg x 11.5” Wide (front) x 6.1” H |
| Inside dims - 12.5” Lg x 11.0” W (front) x 3.5” W (rear) x 5.06” H |
| Floor area – 75 square inches |
| Capacity – 5 - 25g mice |
| Cage Material – Makrolon® polycarbonate or Udel® polysulfone |
| Feeder – polished stainless steel wire, .51 liter (17 oz) capacity |
| Water Bottle – 400 ml (13.5 oz) |
| Enrichment – raised shelves at front and rear of cage |

The following items are available as options:

- Trough tunnel that provides enrichment for the animal population
- OptiMICE rack available with Edstrom or SE Lab Group automatic watering option
- Udel® M2000 amber polysulfone cage assemblies
- Udel® M2300 clear polysulfone cage assemblies
- Large Capacity Feeder, .89 liter (30 oz) capacity

The OptiMICE System offers closed-system, barrier isolation caging system providing unparalleled ease-of- use while maximizing population density and improving the welfare of both animals and caretakers.

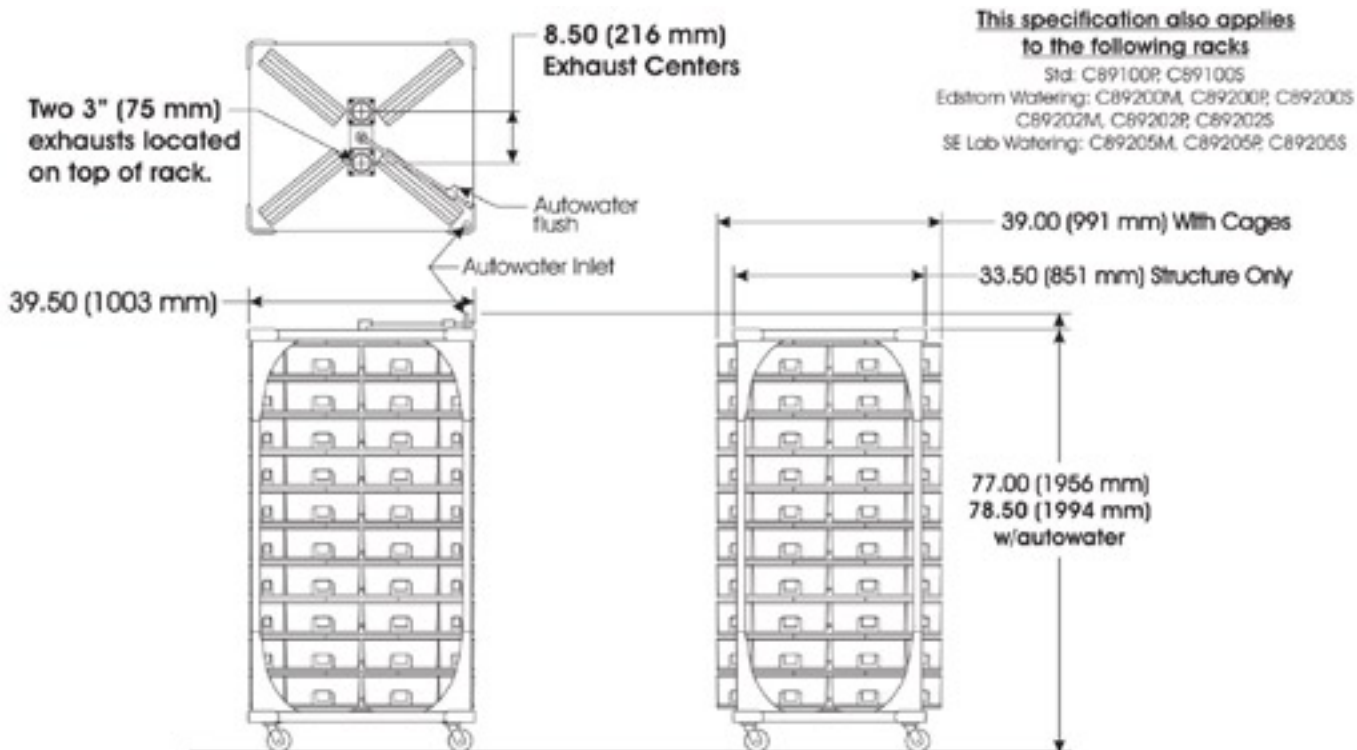

This specification also applies to the following racks
 Std. C89100R, C89100S
 Edstrom Watering: C89200M, C89200R, C89200S
 C89202M, C89202R, C89202S
 SE Lab Watering: C89205M, C89205R, C89205S

OptiMICE C89100M Rack Specifications & Dimensions

Dimensions in inches (millimeters)

| | |
|--|---|
|  ANIMAL CARE SYSTEMS | Part Name: C89100M |
| | Engineering Specification Sheet |
| Drawn by: S. Corell | Date: 1/07/05 |
| Revised: 2/14/05 Added top view 2/25/05 mfr. dims added | 3/30/05 Revised 60 CFM pressure 11/07/06 Added autowater details |

Sheet 2

Weight – 558 Lbs (253 kg) with cages
 Weight w/autowater -- 565Lbs (256 kg)
 Autowater Connections – Type M stainless steel hose connection
 Minimum Ventilation – 40 CFM (1120 l/m), 0.10" W.G. (25 pa)
 Recommended Ventilation – 60 CFM (1680 l/m), .15"-.18" W.G. (38-45 pa)
 Minimum Ceiling Exhaust – 4" (100 mm) Dia. Duct
 Exhaust Hose – 2 ea. 3" (75 mm) Dia. Flexible x 120' (3050 mm) Lg.

ErgoMICE50 Rack

The ErgoMICE50 exhaust vented carousel caging system offers a unique means of rodent housing in the animal care industry. This system is unmatched in space-efficiency and its ability to house rodents in the best possible environmental conditions. The convection-assisted, low velocity, one-pass airflow through each cage provides animals with the gentle ventilation necessary to ensure maximum comfort in an ideal, low-stress living and breeding environment. With no motors or blowers, ErgoMICE50 equipped rooms are virtually noise, vibration, and odor-free. And the ErgoMICE50 rack allows cage access from a comfortable working level.

ErgoMICE50 C89150M Rack Specifications

50-Cage Rack Assembly, Polycarbonate (also available in amber or clear polysulfone)

- Includes complete stainless steel rack assembly with reinforced polymer carousel, cages, casters, and 1 vent hose assembly
- Includes 50 mouse cage assemblies with filters, feeders, cage cards, and water bottles
- Rack Dimensions/50 cages -- 39.5”L x 39.0”W x 63.8” H. (1003 L x 991 W x 1621 H.)
- Rack Dimensions with 4 columns of cages removed for door clearance -- 39.5”L x 33.5”W x 63.8” H (1003 L x 851 W x 1621 H.)
- Vent hose mounts at top center of rack with quick-disconnect fitting
- 388 lbs (176 kg) complete and ready for installation
- Rack assembly is mounted on stainless steel casters with 4” (100 mm) diameter hi-temp wheels. Two casters are provided with brakes and locks
- Air flow requirements – 30 CFM (846 l/m) recommended, 20 CFM (564 l/m) minimum per rack
- Full-height handles at all four corners of rack
- Pleated high-flow Reemay filter assemblies with integral faceplates

| Cage Specific Information |
|---|
| Outside dims – 13.5” (343 mm) Lg x 11.5” (292 mm) Wide (front) x 6.1” (155mm) H |
| Inside dims - 12.5” (318 mm) Lg x 11.0” (279 mm) W (front) x 3.5” (89 mm) W (rear) x 5.06” (129 mm) H |
| Floor area – 75 square inches (484 square centimetres) |
| Capacity – 5 - 25g mice |
| Cage Material – Makrolon® polycarbonate or Udel® polysulfone |
| Feeder – polished stainless steel wire, .51 liter (17 fl. oz) capacity |
| Water Bottle – 400 ml (13.5 oz) |
| Enrichment – raised shelves at front and rear of cage |

The following are some of the options available with the ErgoMICE50 rack:

- Trough tunnel that provides enrichment for the animal population
- OptiMICE rack available with Edstrom or SE Lab Group automatic watering option
- Udel® M2000 amber polysulfone cage assemblies
- Udel® M2300 clear polysulfone cage assemblies
- Large Capacity Feeder, .89 liter (30 fl. oz) capacity

The ErgoMICE System offers closed-system, barrier isolation caging system providing unparalleled ease-of-use while maximizing population density and improving the welfare of both animals and caretakers.

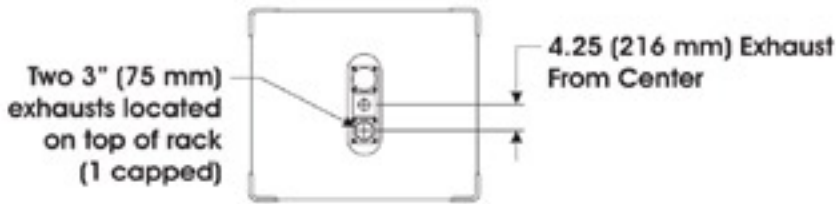

This specification also applies to the following racks
 Std: C89150R, C89150S
 Watering option not available on the ErgoMICE50

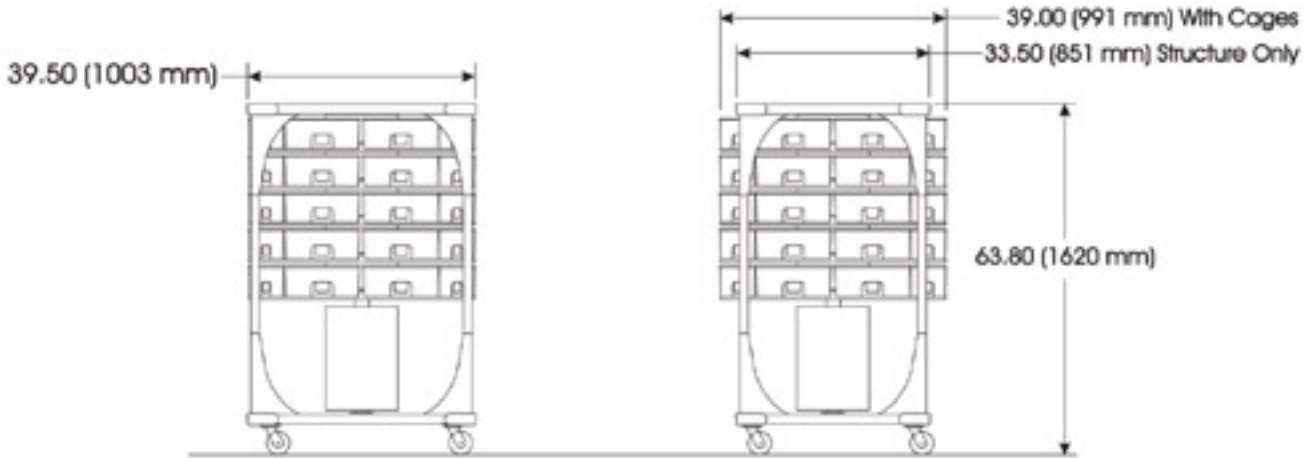

OptiMICE C89150M Rack Specifications & Dimensions

Dimensions in inches (millimeters)

| | |
|---|---------------------------------|
|  ANIMAL CARE SYSTEMS | Part Name: C89150M |
| | Engineering Specification Sheet |
| Drawn by: S. Corell | Date: 3/30/06 |
| Revised: 040907 revised part no., deleted outwater availability | |

Sheet 2

Weight – 388 Lbs (176 kg) with cages
 Minimum Ventilation – 20 CFM (564 l/m), 0.10" W.G. (25 pa)
 Recommended Ventilation – 30 CFM (846 l/m), .15"-.18" W.G. (38-45 pa)
 Minimum Ceiling Exhaust – 4" (100 mm) Dia. Duct
 Exhaust Hose – 1 ea. 3" (75 mm) Dia. Flexible x 120" (3050 mm) Lg.

ErgoMICE70 Rack

The ErgoMICE70 exhaust vented carousel caging system offers a unique means of rodent housing in the animal care industry. This system is unmatched in space-efficiency and its ability to house rodents in the best possible environmental conditions. The convection-assisted, low velocity, one-pass airflow through each cage provides animals with the gentle ventilation necessary to ensure maximum comfort in an ideal, low-stress living and breeding environment. With no motors or blowers, ErgoMICE70 equipped rooms are virtually noise, vibration, and odor-free. And the ErgoMICE70 rack allows cage access from a comfortable working level.

ErgoMICE70 C89170M Rack Specifications

70-Cage Rack Assembly, Polycarbonate (also available in amber or clear polysulfone)

- Includes complete stainless steel rack assembly with reinforced polymer carousel, cages, casters, and 2 vent hose assemblies
- Includes 70 mouse cage assemblies with filters, feeders, cage cards, and water bottles
- Rack Dimensions/70 cages -- 39.5”L x 39.0”W x 77.0” H. (1003 L x 991 W x 1956 H.)
- Rack Dimensions with 4 columns of cages removed for door clearance -- 39.5”L x 33.5”W x 77.0” H (1003 L x 851 W x 1956 H.)
- Vent hoses mount at top center of rack with quick-disconnect fittings
- 463 lbs (210 kg) complete and ready for installation
- Rack assembly is mounted on stainless steel casters with 4” (100 mm) diameter hi-temp wheels. Two casters are provided with brakes and locks
- Air flow requirements – 45 CFM (1269 l/m) recommended, 30 CFM (846 l/m) minimum per rack
- Full-height handles at all four corners of rack
- Pleated high-flow Reemay filter assemblies with integral faceplates

| Cage Specific Information |
|---|
| Outside dims – 13.5” (343 mm) Lg x 11.5” (292 mm) Wide (front) x 6.1” (155mm) H |
| Inside dims - 12.5” (318 mm) Lg x 11.0” (279 mm) W (front) x 3.5” (89 mm) W (rear) x 5.06” (129 mm) H |
| Floor area – 75 square inches (484 square centimetres) |
| Capacity – 5 - 25g mice |
| Cage Material – Makrolon® polycarbonate or Udel® polysulfone |
| Feeder – polished stainless steel wire, .51 liter (17 fl. oz) capacity |
| Water Bottle – 400 ml (13.5 oz) |
| Enrichment – raised shelves at front and rear of cage |

The following are some of the options available with the ErgoMICE70 rack:

- Trough tunnel that provides enrichment for the animal population
- Udel® M2000 amber polysulfone cage assemblies
- Udel® M2300 clear polysulfone cage assemblies
- Large Capacity Feeder, .89 liter (30 fl. oz) capacity

The ErgoMICE System offers closed-system, barrier isolation caging system providing unparalleled ease-of-use while maximizing population density and improving the welfare of both animals and caretakers.

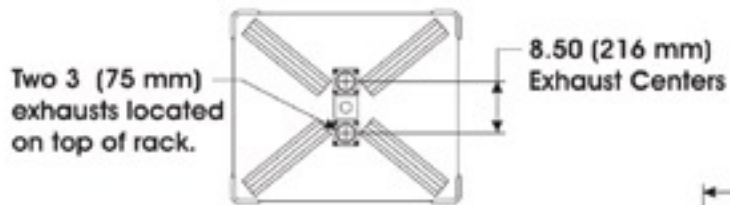

This specification also applies to the following racks
 Std: C89170R, C89170S
 Watering option not available on the ErgoMICE70

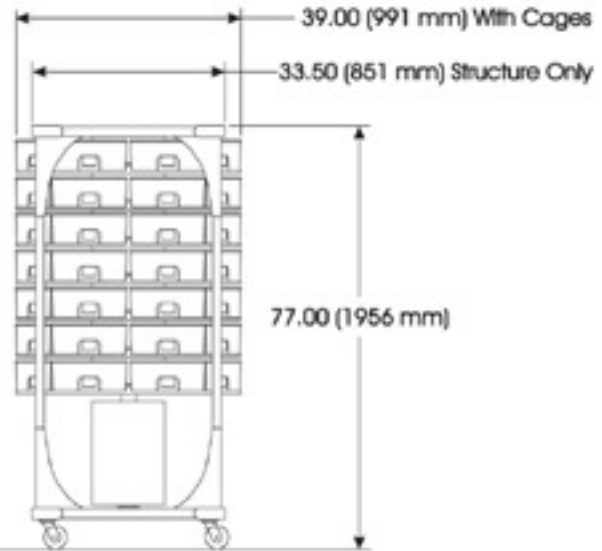
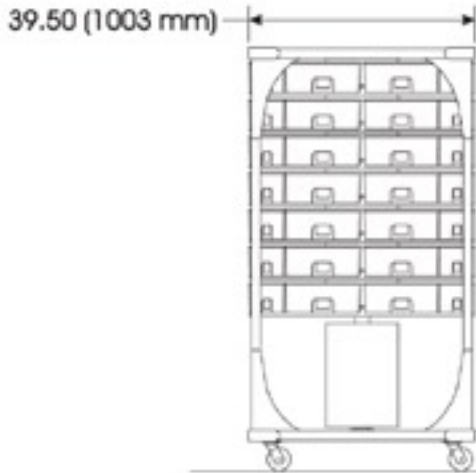

OptiMICE C89170M Rack Specifications & Dimensions

Dimensions in Inches (millimeters)

| | |
|---|--|
|  ANIMAL CARE SYSTEMS | Part Name: C89170M |
| | Engineering Specification Sheet |
| Drawn by: S. Corell | Date: 3/30/06 |
| Revised: 040907 Revised part no., deleted outwater availability | |

Weight 463 Lbs (210 kg) with cages
 Minimum Ventilation 30 CFM (840 l/m), 0.10 W.G. (25 pa)
 Recommended Ventilation 45 CFM (1260 l/m), .15-.18 W.G. (38-45 pa)
 Minimum Ceiling Exhaust 4 (100 mm) Dia. Duct
 Exhaust Hose 2 ea. 3 (75 mm) Dia. Flexible x 120' (3050 mm) Lg.

Sheet 2

ErgoMICE80 Rack

The ErgoMICE80 exhaust vented carousel caging system offers a unique means of rodent housing in the animal care industry. This system is unmatched in space-efficiency and its ability to house rodents in the best possible environmental conditions. The convection-assisted, low velocity, one-pass airflow through each cage provides animals with the gentle ventilation necessary to ensure maximum comfort in an ideal, low-stress living and breeding environment. With no motors or blowers, ErgoMICE80 equipped rooms are virtually noise, vibration, and odor-free. And the ErgoMICE80 rack allows cage access from a comfortable working level.

ErgoMICE80 C89180M Rack Specifications

80-Cage Rack Assembly, Polycarbonate (also available in amber or clear polysulfone)

- Includes complete stainless steel rack assembly with reinforced polymer carousel, cages, casters, and 2 vent hose assemblies
- Includes 80 mouse cage assemblies with filters, feeders, cage cards, and water bottles
- Rack Dimensions/80 cages -- 39.5”L x 39.0”W x 63.8” H. (1003 L x 991 W x 1621 H.)
- Rack Dimensions with 4 columns of cages removed for door clearance -- 39.5”L x 33.5”W x 63.8” H (1003 L x 851 W x 1621 H.)
- Vent hoses mount at top center of rack with quick-disconnect fittings
- 479 lbs (217 kg) complete and ready for installation
- Rack assembly is mounted on stainless steel casters with 4” (100 mm) diameter hi-temp wheels. Two casters are provided with brakes and locks.
- Air flow requirements – 48 CFM (1354 l/m) recommended, 32 CFM (902 l/m) minimum per rack
- Full-height handles at all four corners of rack
- Pleated high-flow Reemay filter assemblies with integral faceplates

| Cage Specific Information |
|---|
| Outside dims – 13.5” (343 mm) Lg x 11.5” (292 mm) Wide (front) x 6.1” (155mm) |
| Inside dims - 12.5” (318 mm) Lg x 11.0” (279 mm) W (front) x 3.5” (89 mm) W (rear) x 5.06” (129 mm) H |
| Floor area – 75 square inches (484 square centimetres) |
| Capacity – 5 - 25g mice |
| Cage Material – Makrolon® polycarbonate or Udel® polysulfone |
| Feeder – polished stainless steel wire, .51 liter (17 fl. oz) capacity |
| Water Bottle – 400 ml (13.5 oz) |
| Enrichment – raised shelves at front and rear of cage |

The following are some of the options available with the ErgoMICE80 rack:

- Trough tunnel that provides enrichment for the animal population
- The ErgoMICE70 rack is available with Edstrom and SE Lab Group automatic watering.
- Udel® M2000 amber polysulfone cage assemblies
- Udel® M2300 clear polysulfone cage assemblies
- Large Capacity Feeder, .89 liter (30 fl. oz) capacity

The ErgoMICE System offers closed-system, barrier isolation caging system providing unparalleled ease-of-use while maximizing population density and improving the welfare of both animals and caretakers.

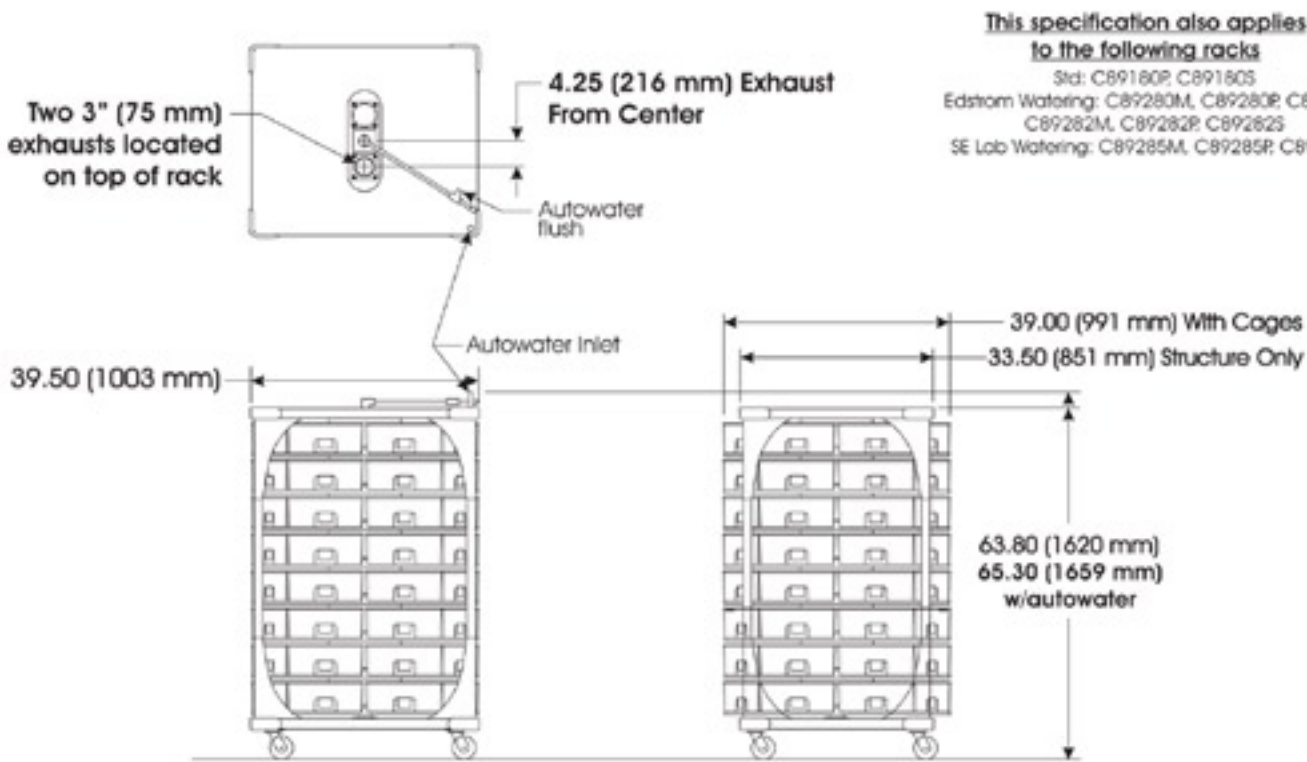

This specification also applies to the following racks
 Sid: C89180P, C89180S
 Edstrom Watering: C89280M, C89280R, C89280S
 C89282M, C89282P, C89282S
 SE Lab Watering: C89285M, C89285P, C89285S

OptiMICE C89280M Rack Specifications & Dimensions

Dimensions in inches (millimeters)

| | |
|---|---------------------------------|
|  ANIMAL CARE SYSTEMS | Part Name: C89280M |
| | Engineering Specification Sheet |
| Drawn by: S. Corell | Date: 3/30/06 |
| Revised: 040907 revised part nos., added outowater details | |

Sheet 2

- Weight – 479 Lbs (217 kg) with cages
- Weight w/autowater – 486 Lbs (220 kg)
- Minimum Ventilation – 32 CFM (902 l/m), 0.10" W.G. (25 pa)
- Recommended Ventilation – 48 CFM (1354 l/m), .15"-.18" W.G. (38-45 pa)
- Minimum Ceiling Exhaust – 4" (100 mm) Dia. Duct
- Exhaust Hose – 2 ea. 3" (75 mm) Dia. Flexible x 120" (3050 mm) Lg.

OptiRAT Rack

The OptiRAT exhaust vented carousel rat caging system offers a unique means of large rodent housing in the animal care industry. This system is unmatched in space-efficiency and its ability to house rats in the best possible environmental conditions. The convection-assisted, low velocity, one-pass airflow through each cage provides animals with the gentle ventilation necessary to ensure maximum comfort in an ideal, low-stress living and breeding environment. With no motors or blowers, OptiRAT equipped rooms are virtually noise, vibration, and odor-free.

OptiRAT C86100X Rack Specifications

- 42-CageRat Rack Assembly, available in Polycarbonate (M suffix), amber polysulfone (P suffix), or smoke polysulfone (S suffix)
- Includes complete stainless steel rack assembly with reinforced polymer carousel, cage assemblies, casters, and 2 vent hose assemblies
 - Includes 42 rat cage assemblies with filters, feeders, cage cards, and water bottles
 - Rack Dimensions -- 39.5”L x 39.0”W x 77.0” H
 - Rack Dimensions with 14 cages -- 39.5”L x 33.0”W x 77.0” H.
(4 columns of cages removed for door clearance)
 - Two vent hoses mount near top center of rack with quick-disconnect fittings.
 - 550 lbs (250 kg) complete and ready for installation
 - Rack assembly is mounted on stainless steel casters with 4” diameter hi-temp ball bearing wheels. Two casters are provided with brakes and locks.
 - Air flow requirements – 82 CFM recommended, 55 CFM minimum per rack
 - Full-height handles at each corner
 - Pleated high-flow Reemay filter assemblies

| Cage Specific Information | |
|---|--|
| OptiRAT Cage | |
| Outside dims – 14”(356 mm) L x 19.1”(485 mm) W x 8.6”(218 mm) H including feet | |
| Inside dims – 12.8”(325 mm) L x 18.5”(470 mm) W (front) x 6.5”(165 mm) W (rear) x 8.1”(20.5 cm) H | |
| Floor area – 144 square inches (1032 sq. cm.) | |
| Capacity – 2 rats 500 grams or heavier, 4 rats less than 400 grams | |
| Cage Material – Makrolon® polycarbonate or Udel® polysulfone (amber or smoke color) | |
| Feeder – polished stainless steel, 37 oz. (1.1 liter) capacity | |
| Water Bottle – 2 each 400 ml (13.5 oz) | |
| Enrichment – two raised shelves at front of cage | |

The following items are available as options:

- Trough tunnel that provides enrichment for the animal population
- OptiRAT rack available with automatic watering option
- Udel® M2000 amber polysulfone cage assemblies
- Udel® M2300 clear polysulfone cage assemblies

The OptiRAT System offers closed-system, barrier isolation caging system providing unparalleled ease-of-use while maximizing population density and improving the welfare of both animals and caretakers.

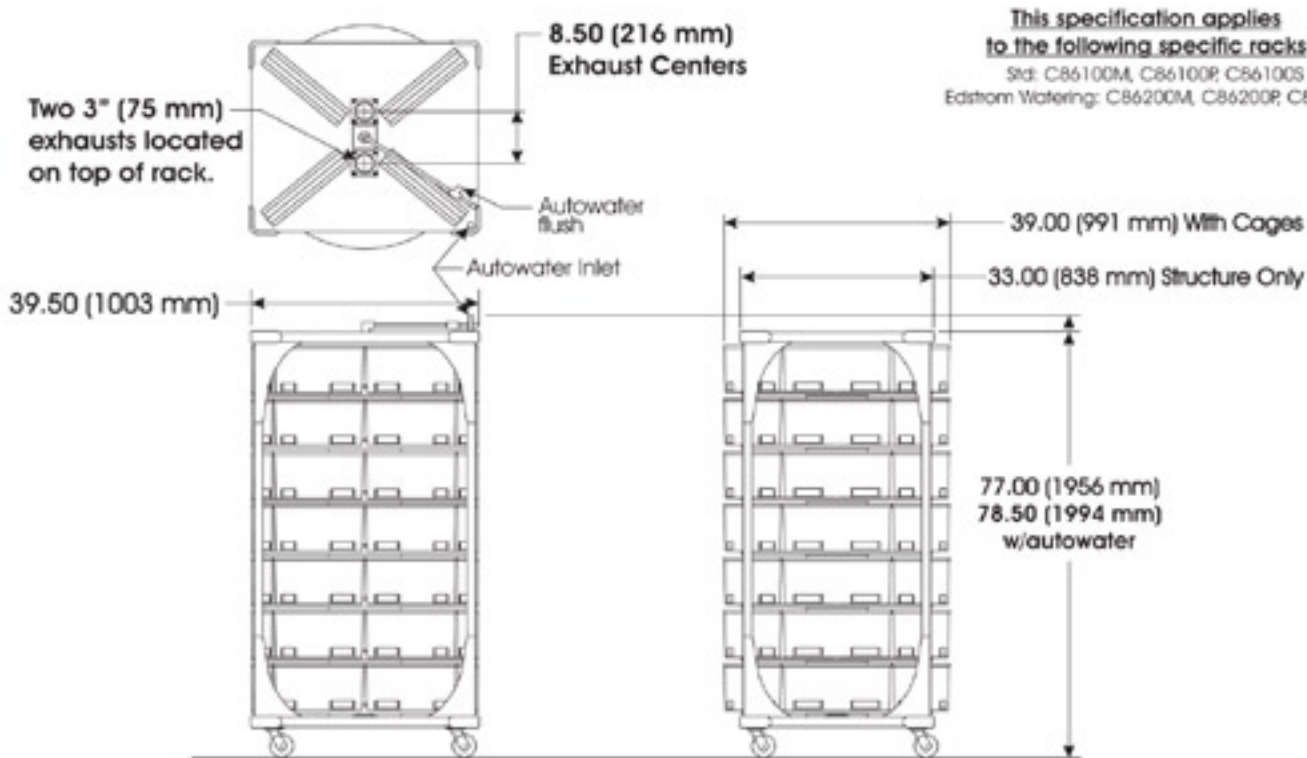

This specification applies to the following specific racks
 Std: C86100M, C86100P, C86100S
 Edstrom Watering: C86200M, C86200P, C86200S

OptiRAT C86100X Rack Specifications & Dimensions

Dimensions in inches (millimeters)

| | |
|---|---------------------------------|
|  ANIMAL CARE SYSTEMS, INC. | Part Name: C86100X |
| | Engineering Specification Sheet |
| Drawn by: S. Corell | Date: 09/20/07 |
| Revised: 20Nov2007 | |

Sheet 2

- Weight – Approx 550 Lbs (250 kg) with cages
- Weight w/autowater -- 565Lbs (256 kg)
- Autowater Connections – Type M stainless steel hose connection
- Minimum Ventilation – 55 CFM (1550 l/m), 0.10" W.G. (25 pa)
- Recommended Ventilation – 82 CFM (2312 l/m), .15"-.18" W.G. (38-45 pa)
- Minimum Ceiling Exhaust – 4" (100 mm) Dia. Duct
- Exhaust Hose – 2 ea. 3" (75 mm) Dia. Flexible x 120" (3050 mm) Lg.

M.I.C.E. Rack

The M.I.C.E exhaust vented caging system offers a unique means of rodent housing in the animal care industry. The M.I.C.E. system is unmatched in its ability to house rodents in the best possible environmental conditions. The convection-assisted, low velocity, one pass airflow through each cage provides animals with the gentle ventilation necessary to ensure maximum comfort in an ideal, low-stress living and breeding environment. With no motors or blowers, M.I.C.E. equipped rooms are virtually noise, vibration, and odor-free.

D4 Rack Specifications M85015D4 56-Cage Mouse Rack/M85016D4 28-Cage Rat Rack

4-Module Double Sided Rack Assembly, Polycarbonate (also available in Polysulfone)

- Includes complete rack assembly with shelves, legs, casters, and 1 - 2 vent hose assemblies
- Includes 56 mouse cage assemblies or 28 rat cage assemblies
- 32.5”L x36.5”D x 77.0” H
- R567 lbs including 56 mouse cage or 28 rat cage assemblies
- Rack assembly is mounted on stainless steel casters with 4” diameter wheels.
- Minimum air flow requirements – 32 CFM per rack.

| Cage Specific Information | |
|--|--|
| Mouse Cage | Rat Cage |
| Outside dims - 15.3” L x 7.8” W x 9.5” H | Outside dims – 15.3” L x 15.8” W x 9.5” H |
| Inside dims - 13.5” L x 7.0” W | Inside dims – 13.5” L x 14.9” W |
| Bottom inner dims – 12.1” L x 6.12” W | Bottom inner dims – 12.1” L x 14.0” W |
| Floor area – 83 square inches | Floor area – 180 square inches |
| Average height – 6.75” | Average height – 6.75” |
| Capacity – 6 - 25g mice; 2 – 300g rats; 5 – 100g hamsters | Capacity-15–25gmice;6–300grats;100–100g hamsters |
| Cage Material – Makrolon polycarbonate or Udel polysulfone | Cage Material – Makrolon polycarbonate or Udel polysulfone |

The following items are available as options:

- Perforated stainless steel floor insert with integral feeder holder for bedding-free caging
- Cage bottoms can be equipped with stainless steel water valve grommets for an automatic watering system
- Inhalation nozzle that inserts into the front inlet port to deliver ‘test’ air directly into the cage
- Trough tunnel that fits under the feeder and provides enrichment for the animal population

This modular, closed-system, barrier isolation caging system provides maximum flexibility while increasing population density and improving the welfare of both animals and caretakers.

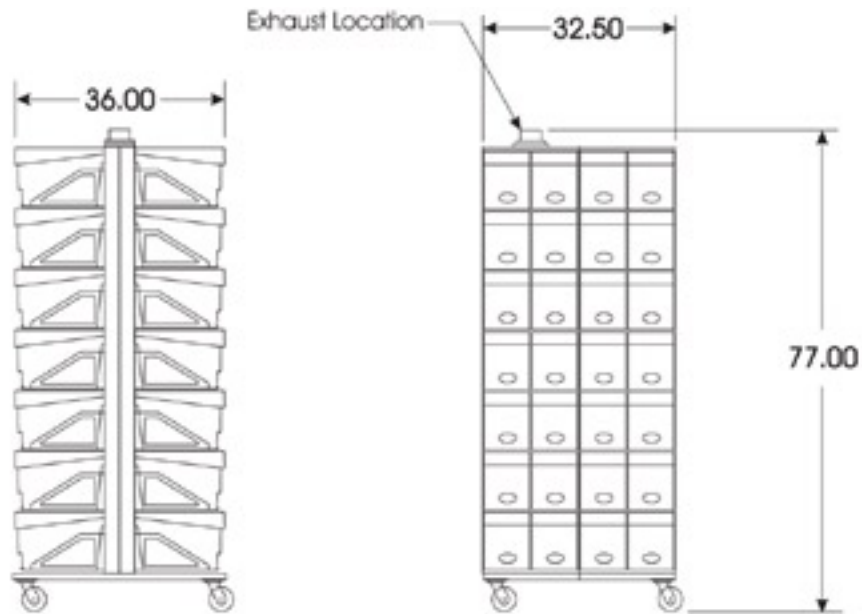

Weight – 567 Lbs with cages
 Minimum Ventilation – 32 CFM, 0.15" W.G.
 Ceiling Exhaust – 1 ea. 3" Dia. Duct**
 Exhaust Hose – 3" Dia. Flexible x 10' Lg.

**Note that larger ducts reduced to 3.00 dia. are acceptable

| | | |
|---|---------------------------------|--|
|  ANIMAL CARE SYSTEMS | Part Name: M85015D4 Rack | |
| | Engineering Specification Sheet | |
| Drawn by: S. Corell | Date: 6/27/02 | |
| Revised: | | |

M85016D4 Rack with 28 rat cages has identical specifications.
 P85016D4 Rack with 28 rat cages has identical specifications.

Sheet 2

M.I.C.E. Rack

The M.I.C.E exhaust vented caging system offers a unique means of rodent housing in the animal care industry. The M.I.C.E. system is unmatched in its ability to house rodents in the best possible environmental conditions. The convection-assisted, low velocity, one pass airflow through each cage provides animals with the gentle ventilation necessary to ensure maximum comfort in an ideal, low-stress living and breeding environment. With no motors or blowers, M.I.C.E. equipped rooms are virtually noise, vibration, and odor-free.

D6 Rack Specifications M85015D6 84-Cage Mouse Rack/M85016D6 42-Cage Rat Rack

6-Module Double Sided Rack Assembly, Polycarbonate (also available in Polysulfone)

- Includes complete rack assembly with shelves, legs, casters, and 2 vent hose assemblies
- Includes 84 mouse cage assemblies or 42 rat cage assemblies
- 48.75" (1238) L x 36.5" (927) D x 78.0" (1981) H
- 779 lbs (353 kg) including 84 mouse cage or 42 rat cage assemblies
- Rack assembly is mounted on stainless steel casters with 5" (125 mm) diameter wheels
- Minimum air flow requirements – 48 CFM (22.5 l/s) per rack

| Cage Specific Information | |
|--|--|
| Mouse Cage | Rat Cage |
| Outside dims - 15.3" L x 7.8" W x 9.5" H. 389 mm L x 198 mm W x 241 mm H | Outside dims – 15.3" L x 15.8" W x 9.5" H 389 mm L x 401 mm W x 241 mm H |
| Inside dims - 13.5" L x 7.0" W 343 mm L x 178 mm W | Inside dims – 13.5" L x 14.9" W 343 mm L x 378 mm W |
| Floor area – 83 square inches (535 sq cm) | Floor area – 180 square inches (1161 sq cm) |
| Average height – 6.75" (171.5 mm) | Average height – 6.75" (171.5 mm) |
| Capacity – 6 - 25g mice; 2 – 300g rats; 5 – 100g hamsters | Capacity - 15 – 25g mice; 6 – 300g rats; 100 – 100g hamsters |
| Cage Material – Makrolon polycarbonate or Udel polysulfone | Cage Material – Makrolon polycarbonate or Udel polysulfone |

The following items are available as options:

- Perforated stainless steel floor insert with integral feeder holder for bedding-free caging
- Cage bottoms can be equipped with stainless steel water valve grommets for an automatic watering system
- Inhalation nozzle that inserts into the front inlet port to deliver 'test' air directly into the cage
- Trough tunnel that fits under the feeder and provides enrichment for the animal population

This modular, closed-system, barrier isolation caging system provides maximum flexibility while increasing population density and improving the welfare of both animals and caretakers.

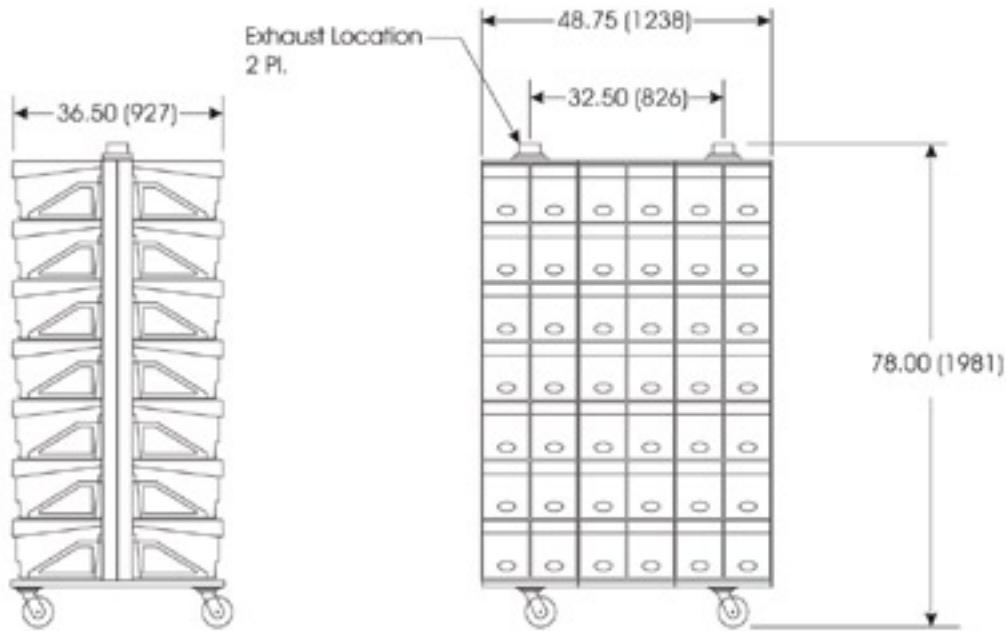

Weight 849 Lbs (385 kg) with cages
 Minimum Ventilation 48 CFM (22.5 l/s), 0.15 W.G.(38 pa)
 Ceiling Exhaust 2 ea. 3 (75mm) Dia. Duct**
 Exhaust Hoses 3 (75 mm) Dia. Flexible x 10 (3 m) Lg.

**Note that alternate ceiling exhaust configurations are acceptable

| | |
|---|--|
|  ANIMAL CARE SYSTEMS | Part Name: M85015D6 Rack |
| | Engineering Specification Sheet |
| Drawn by: S. Correll | Date: 6/27/02 |
| Revised: | |

M85016D6 Rack with 42 rat cages has identical specifications.
 P85016D6 Rack with 42 rat cages has identical specifications.

Sheet 2

M.I.C.E. Rack

The M.I.C.E exhaust vented caging system offers a unique means of rodent housing in the animal care industry. The M.I.C.E. system is unmatched in its ability to house rodents in the best possible environmental conditions. The convection-assisted, low velocity, one pass airflow through each cage provides animals with the gentle ventilation necessary to ensure maximum comfort in an ideal, low-stress living and breeding environment. With no motors or blowers, M.I.C.E. equipped rooms are virtually noise, vibration, and odor-free.

D8 Rack Specifications M85015D8 112-Cage Mouse Rack/M85016D8 56-Cage Rat Rack

8-Module Double Sided Rack Assembly, Polycarbonate (also available in Polysulfone)

- Includes complete rack assembly with shelves, legs, casters, and 2 vent hose assemblies
- Includes 112 mouse cage assemblies or 56 rat cage assemblies
- 65.0" (1651) L x 36.5" (927) D x 78.0" (1981) H
- 1038 lbs (471 kg) including 112 mouse cage or 56 rat cage assemblies
- Rack assembly is mounted on stainless steel casters with 5" (125 mm) diameter wheels
- Minimum air flow requirements – 64 CFM (30 l/s) per rack

| Cage Specific Information | |
|--|---|
| Mouse Cage | Rat Cage |
| Outside dims - 15.3" L x 7.8" W x 9.5" H. 389 mm L x 198 mm W x 241 mm H | Outside dims – 15.3" L x 15.8" W x 9.5" H 389 mm L x 401 mm W x 241mm H |
| Inside dims - 13.5" L x 7.0" W 343 mm L x 178 mm W | Inside dims – 13.5" L x 14.9" W 343 mm L x 378 mm W |
| Floor area – 83 square inches (535 sq cm) | Floor area – 180 square inches (1161 sq cm) |
| Average height – 6.75" (171.5 mm) | Average height – 6.75" (171.5 mm) |
| Capacity – 6 - 25g mice; 2 – 300g rats; 5 – 100g hamsters | Capacity - 15 – 25g mice; 6 – 300g rats; 100 – 100g hamsters |
| Cage Material – Makrolon polycarbonate or Udel polysulfone | Cage Material – Makrolon polycarbonate or Udel polysulfone |

The following items are available as options:

- Perforated stainless steel floor insert with integral feeder holder for bedding-free caging
- Cage bottoms can be equipped with stainless steel water valve grommets for an automatic watering system
- Inhalation nozzle that inserts into the front inlet port to deliver 'test' air directly into the cage
- Trough tunnel that fits under the feeder and provides enrichment for the animal population

This modular, closed-system, barrier isolation caging system provides maximum flexibility while increasing population density and improving the welfare of both animals and caretakers.

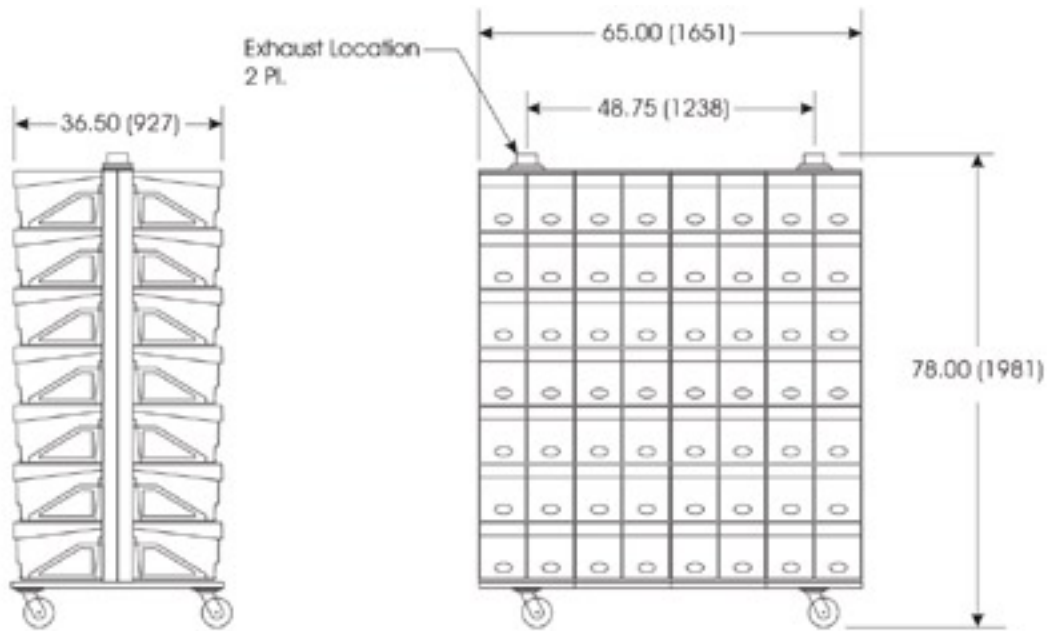

Weight 1038 Lb (471 Kg) with cages
 Minimum Ventilation 64 CFM (30 l/s), 0.15 W.G.(38 pa)
 Ceiling Exhaust 2 ea. 3 (75 mm) Dia. Duct**
 Exhaust Hoses 3 (75 mm) Dia. Flexible x 10 (3.0 m) Lg

**Note that alternate ceiling exhaust configurations are acceptable

| | | |
|--|---------------------------------|--|
|  ANIMAL CARE SYSTEMS | Part Name: M85015D8 Rack | |
| | Engineering Specification Sheet | |
| Drawn by: S.Corell | Date: 6/27/02 | |
| Revised: | | |

M85016D8 Rack with 56 rat cages has identical specifications.
 P85016D8 Rack with 56 rat cages has identical specifications.

Sheet 2

M.I.C.E. Rack

The M.I.C.E exhaust vented caging system offers a unique means of rodent housing in the animal care industry. The M.I.C.E. system is unmatched in its ability to house rodents in the best possible environmental conditions. The convection-assisted, low velocity, one pass airflow through each cage provides animals with the gentle ventilation necessary to ensure maximum comfort in an ideal, low-stress living and breeding environment. With no motors or blowers, M.I.C.E. equipped rooms are virtually noise, vibration, and odor-free.

S1 Rack Specifications

M85010S1 14-Cage Mouse Rack/M85011S1 7-Cage Rat Rack

Single Module Rack Assembly, Polycarbonate (also available in Polysulfone)

- Includes complete rack assembly with shelves, legs, casters, and 1 vent hose assembly
- Includes 14 mouse cage assemblies or 7 rat cage assemblies
- 16.25" (413) L x 23.25" (591) D x 77.0" (1956) H
- 147 lbs (67 kg.) including 14 mouse cage or 7 rat cage assemblies
- Rack assembly is mounted on stainless steel casters with 4" (100 mm) diameter wheels
- Minimum air flow requirements – 8 CFM (3.8 l/s) per rack

| Cage Specific Information | |
|--|--|
| Mouse Cage | Rat Cage |
| Outside dims - 15.3" L x 7.8" W x 9.5" H. 389 mm L x 198 mm W x 241 mm H | Outside dims – 15.3" L x 15.8" W x 9.5" H 389 mm L x 401 mm W x 241 mm H |
| Inside dims - 13.5" L x 7.0" W 343 mm L x 178 mm W | Inside dims – 13.5" L x 14.9" W 343 mm L x 378 mm W |
| Floor area – 83 square inches (535 sq cm) | Floor area – 180 square inches (1161 sq cm) |
| Average height – 6.75" (171.5 mm) | Average height – 6.75" (171.5 mm) |
| Capacity – 6 - 25g mice; 2 – 300g rats; 5 – 100g hamsters | Capacity - 15 – 25g mice; 6 – 300g rats; 100 – 100g hamsters |
| Cage Material – Makrolon polycarbonate or Udel polysulfone | Cage Material – Makrolon polycarbonate or Udel polysulfone |

The following items are available as options:

- Perforated stainless steel floor insert with integral feeder holder for bedding-free caging
- Cage bottoms can be equipped with stainless steel water valve grommets for an automatic watering system
- Inhalation nozzle that inserts into the front inlet port to deliver 'test' air directly into the cage
- Trough tunnel that fits under the feeder and provides enrichment for the animal population

This modular, closed-system, barrier isolation caging system provides maximum flexibility while increasing population density and improving the welfare of both animals and caretakers.

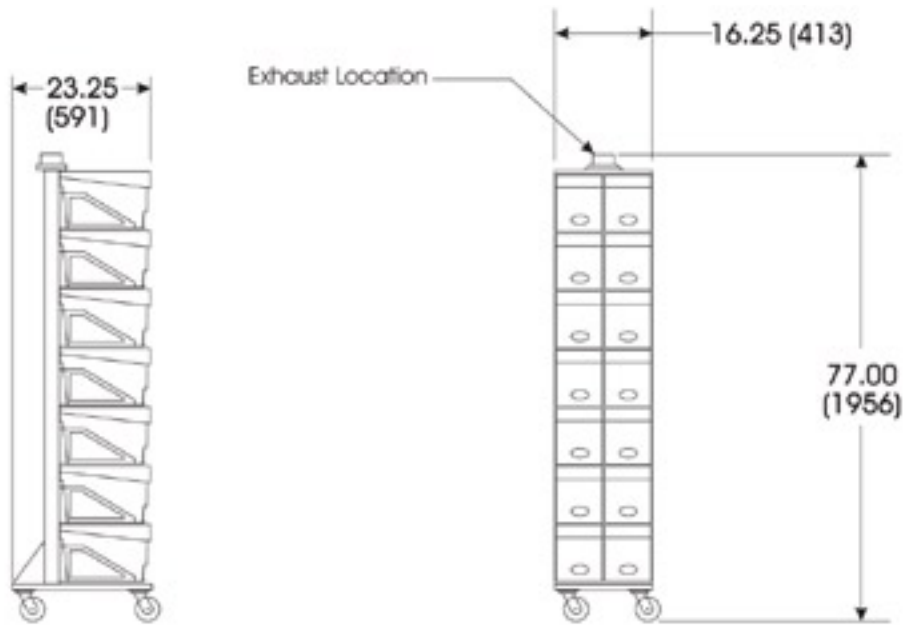

Weight – 147 Lbs (67 kg) with cages
 Minimum Ventilation – 8 CFM (3.8 l/s), 0.10" W.G. (25 pa)
 Ceiling Exhaust – 1 ea. 3" (75 mm) Dia. Duct**
 Exhaust Hose – 3" (75 mm) Dia. Flexible x 10' (3 m) Lg.

Dimensions in inches (mm)

| | | |
|---|---------------------------------|--|
|  ANIMAL CARE SYSTEMS, INC. | Part Name: M85010S1 Rack | |
| | Engineering Specification Sheet | |
| Drawn by: S. Correll | Date: 6/07/02 | |
| Revised: 2/3/5 | | |

**Note that larger ceiling exhausts are acceptable when used with reducer.

M85011S1 Rack with 7 rat cages has identical specifications.
 P85011S1 Rack with 7 rat cages has identical specifications.

Sheet 2

M.I.C.E. Rack

The M.I.C.E exhaust vented caging system offers a unique means of rodent housing in the animal care industry. The M.I.C.E. system is unmatched in its ability to house rodents in the best possible environmental conditions. The convection-assisted, low velocity, one pass airflow through each cage provides animals with the gentle ventilation necessary to ensure maximum comfort in an ideal, low-stress living and breeding environment. With no motors or blowers, M.I.C.E. equipped rooms are virtually noise, vibration, and odor-free.

S2 Rack Specifications M85010S2 28-Cage Mouse Rack/M85011S2 14-Cage Rat Rack

2 – Module Single Sided Rack Assembly, Polycarbonate (also available in Polysulfone)

- Includes complete rack assembly with shelves, legs, casters, and 1 vent hose assembly
- Includes 28 mouse cage assemblies or 14 rat cage assemblies
- 32.5”L x 23.25”D x 77.0” H
- 289 lbs including 28 mouse cage or 14 rat cage assemblies
- Rack assembly is mounted on stainless steel casters with 4” diameter wheels
- Minimum air flow requirements – 16 CFM per rack

| Cage Specific Information | |
|--|--|
| Mouse Cage | Rat Cage |
| Outside dims - 15.3” L x 7.8” W x 9.5” H | Outside dims – 15.3” L x 15.8” W x 9.5” H |
| Inside dims - 13.5” L x 7.0” W | Inside dims – 13.5” L x 14.9” W |
| Bottom inner dims – 12.1” L x 6.12” W | Bottom inner dims – 12.1” L x 14.0” W |
| Floor area – 83 square inches | Floor area – 180 square inches |
| Average height – 6.75” | Average height – 6.75” |
| Capacity – 6 - 25g mice; 2 – 300g rats; 5 – 100g hamsters | Capacity-15 – 25g mice; 6 – 300g rats; 100 – 100g hamsters |
| Cage Material – Makrolon polycarbonate or Udel polysulfone | Cage Material – Makrolon polycarbonate or Udel polysulfone |

The following items are available as options:

- Perforated stainless steel floor insert with integral feeder holder for bedding-free caging
- Cage bottoms can be equipped with stainless steel water valve grommets for an automatic watering system
- Inhalation nozzle that inserts into the front inlet port to deliver ‘test’ air directly into the cage
- Trough tunnel that fits under the feeder and provides enrichment for the animal population

This modular, closed-system, barrier isolation caging system provides maximum flexibility while increasing population density and improving the welfare of both animals and caretakers.

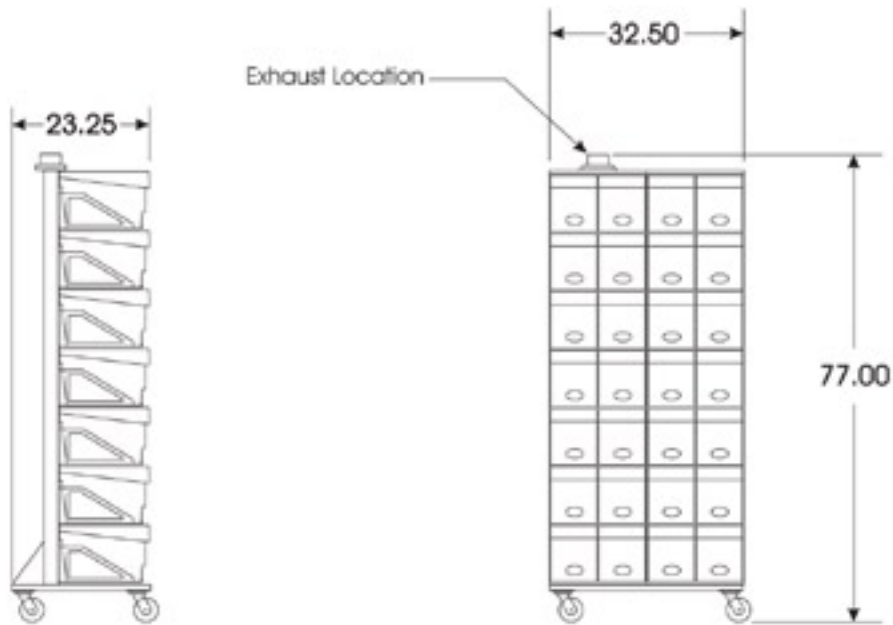

Weight – 289 Lbs with cages
 Minimum Ventilation – 16 CFM, 0.15" W.G.
 Ceiling Exhaust – 1 ea. 3" Dia. Duct**
 Exhaust Hose – 3" Dia. Flexible x 10' Lg.

**Note that larger ceiling exhausts are acceptable when used with reducer.

M85011S2 Rack with 14 rat cages has identical specifications.
 P85011S2 Rack with 14 rat cages has identical specifications.

| | |
|---|---------------------------------|
|  ANIMAL CARE SYSTEMS | Part Name: M85010S2 Rack |
| | Engineering Specification Sheet |
| Drawn by: S. Correll | Date: 6/07/02 |
| Revised: | |

Sheet 2

M.I.C.E. Rack

The M.I.C.E exhaust vented caging system offers a unique means of rodent housing in the animal care industry. The M.I.C.E. system is unmatched in its ability to house rodents in the best possible environmental conditions. The convection-assisted, low velocity, one pass airflow through each cage provides animals with the gentle ventilation necessary to ensure maximum comfort in an ideal, low-stress living and breeding environment. With no motors or blowers, M.I.C.E. equipped rooms are virtually noise, vibration, and odor-free.

S3 Rack Specifications M85010S3 42-Cage Mouse Rack/M85011S3 21-Cage Rat Rack

3 – Module Single Sided Rack Assembly, Polycarbonate (also available in Polysulfone)

- Includes complete rack assembly with shelves, legs, casters, and 1 vent hose assembly
- Includes 42 mouse cage assemblies or 21 rat cage assemblies
- 48.75" (1238) L x 23.25" (591) D x 77.0" (1956) H
- 402 lbs (182 kg) including 42 mouse cage or 21 rat cage assemblies
- Rack assembly is mounted on stainless steel casters with 4" (100 mm) diameter wheels
- Minimum air flow requirements – 24 CFM (11.3 l/s) per rack

| Cage Specific Information | |
|--|--|
| Mouse Cage | Rat Cage |
| Outside dims - 15.3" L x 7.8" W x 9.5" H. 389 mm L x 198 mm W x 241 mm H | Outside dims – 15.3" L x 15.8" W x 9.5" H 389 mm L x 401 mm W x 241 mm H |
| Inside dims - 13.5" L x 7.0" W 343 mm L x 178 mm W | Inside dims – 13.5" L x 14.9" W 343 mm L x 378 mm W |
| Floor area – 83 square inches (535 sq cm) | Floor area – 180 square inches (1161 sq cm) |
| Average height – 6.75" (171.5 mm) | Average height – 6.75" (171.5 mm) |
| Capacity – 6 - 25g mice; 2 – 300g rats; 5 – 100g hamsters | Capacity - 15 – 25g mice; 6 – 300g rats; 100 – 100g hamsters |
| Cage Material – Makrolon polycarbonate or Udel polysulfone | Cage Material – Makrolon polycarbonate or Udel polysulfone |

The following items are available as options:

- Perforated stainless steel floor insert with integral feeder holder for bedding-free caging
- Cage bottoms can be equipped with stainless steel water valve grommets for an automatic watering system
- Inhalation nozzle that inserts into the front inlet port to deliver 'test' air directly into the cage
- Trough tunnel that fits under the feeder and provides enrichment for the animal population

This modular, closed-system, barrier isolation caging system provides maximum flexibility while increasing population density and improving the welfare of both animals and caretakers.

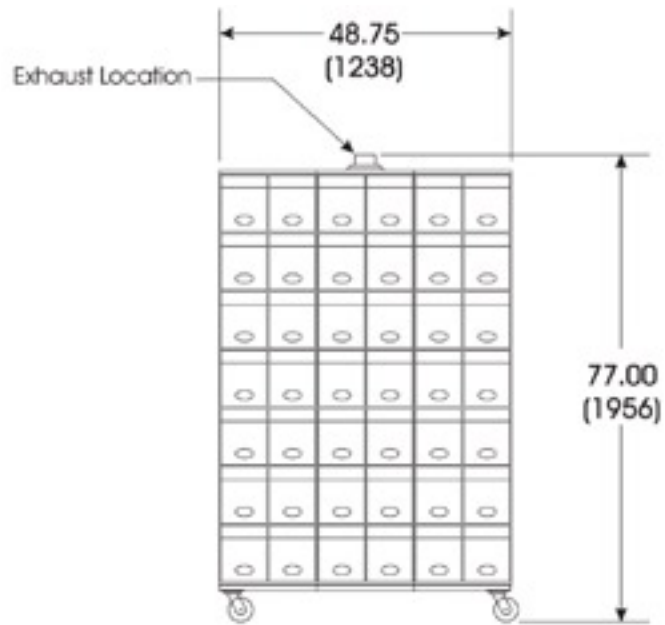
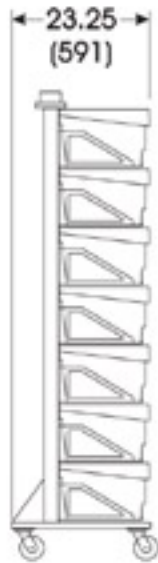

Weight 434 Lbs (197 kg) with cages
 Minimum Ventilation 24 CFM (672 l/m), 0.15 W.G. (38 pa)
 Ceiling Exhaust 1 ea. 3 (75 mm) Dia. Duct**
 Exhaust Hose 3 (75 mm) Dia. Flexible x 10 (3 m) Lg.

Dimensions in inches (mm)

**Note that larger ceiling exhausts are acceptable when used with reducer.

M85011S3 Rack with 21 rat cages has identical specifications.
 P85011S3 Rack with 21 rat cages has identical specifications.

| | | |
|---|---------------------------------|--|
|  ANIMAL CARE SYSTEMS | Part Name: M85010S3 Rack | |
| | Engineering Specification Sheet | |
| Drawn by: S. Correll | Date: 6/07/02 | |
| Revised: 2/3/5 | | |

Sheet 2

M.I.C.E. Rack

The M.I.C.E exhaust vented caging system offers a unique means of rodent housing in the animal care industry. The M.I.C.E. system is unmatched in its ability to house rodents in the best possible environmental conditions. The convection-assisted, low velocity, one pass airflow through each cage provides animals with the gentle ventilation necessary to ensure maximum comfort in an ideal, low-stress living and breeding environment. With no motors or blowers, M.I.C.E. equipped rooms are virtually noise, vibration, and odor-free

S4 Rack Specifications M85010S4 56-Cage Mouse Rack/M85011S4 28-Cage Rat Rack

4 – Module Single Sided Rack Assembly, Polycarbonate (also available in Polysulfone)

- Includes complete rack assembly with shelves, legs, casters, and 1 vent hose assembly
- Includes 56 mouse cage assemblies or 28 rat cage assemblies
- 65.0" (1651) L x 23.25" (591) D x 77.0" (1956) H
- 578 lbs (262 kg) including 56 mouse cage or 28 rat cage assemblies
- Rack assembly is mounted on stainless steel casters with 4" (100 mm) diameter wheels
- Minimum air flow requirements – 32 CFM (15.0 l/s) per rack

| Cage Specific Information | |
|--|--|
| Mouse Cage | Rat Cage |
| Outside dims - 15.3" L x 7.8" W x 9.5" H. 389 mm L x 198 mm W x 241 mm H | Outside dims – 15.3" L x 15.8" W x 9.5" H 389 mm L x 401 mm W x 241 mm H |
| Inside dims - 13.5" L x 7.0" W 343 mm L x 178 mm W | Inside dims – 13.5" L x 14.9" W 343 mm L x 378 mm W |
| Floor area – 83 square inches (535 sq cm) | Floor area – 180 square inches (1161 sq cm) |
| Average height – 6.75" (171.5 mm) | Average height – 6.75" (171.5 mm) |
| Capacity – 6 - 25g mice; 2 – 300g rats; 5 – 100g hamsters | Capacity - 15 – 25g mice; 6 – 300g rats; 100 – 100g hamsters |
| Cage Material – Makrolon polycarbonate or Udel polysulfone | Cage Material – Makrolon polycarbonate or Udel polysulfone |

The following items are available as options:

- Perforated stainless steel floor insert with integral feeder holder for bedding-free caging
- Cage bottoms can be equipped with stainless steel water valve grommets for an automatic watering system
- Inhalation nozzle that inserts into the front inlet port to deliver 'test' air directly into the cage
- Trough tunnel that fits under the feeder and provides enrichment for the animal population

This modular, closed-system, barrier isolation caging system provides maximum flexibility while increasing population density and improving the welfare of both animals and caretakers.

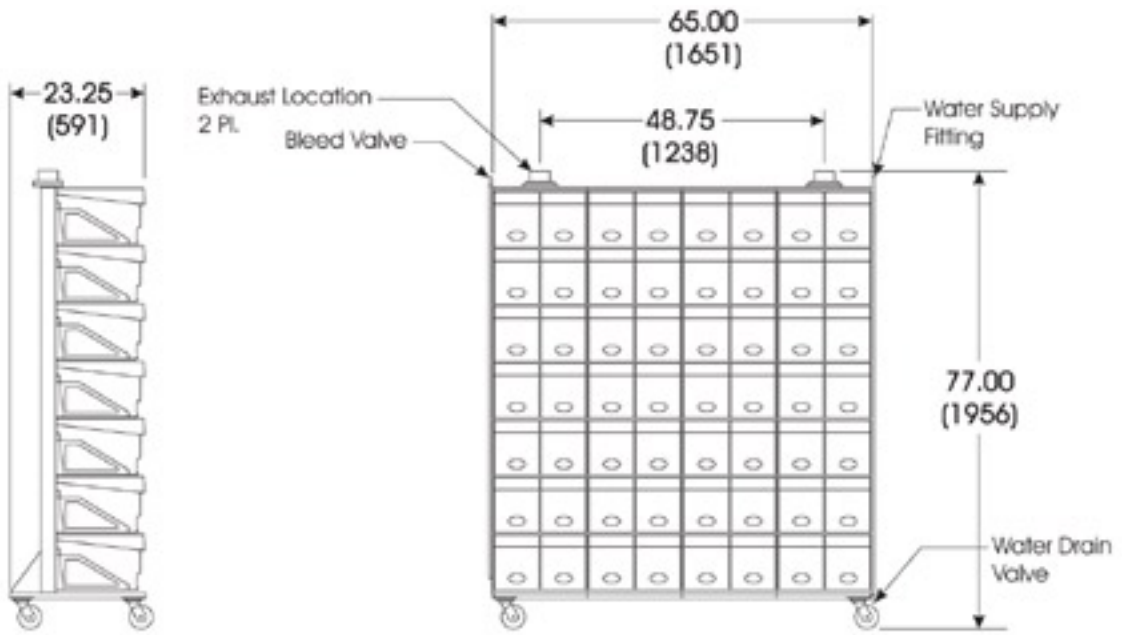

Weight 578 Lbs (262 kg) with cages
 Minimum Ventilation 32 CFM (896 l/m), 0.10 W.G. (25 pa)
 Ideal Ventilation 48 CFM, 0.15 (38 pa) W.G.
 Ceiling Exhaust 2 ea. 3 (75 mm) Dia. Duct**
 Exhaust Hoses 3 (75 mm) Dia. Flexible x 10 (3 m) Lg

Dimensions in inches (mm)

| | |
|---|--|
|  ANIMAL CARE SYSTEMS | Part Name: M85010S4 Rack |
| | Engineering Specification Sheet |
| Drawn by: S. Corell | Date: 6/07/02 |
| Revised: 2/3/5 | |

**Note that larger ceiling exhausts are acceptable when used with reducer.

M85011S4 Rack with 28 rat cages has identical specifications.
 P85011S4 Rack with 28 rat cages has identical specifications.

Sheet 2

M.I.C.E. Rack

The M.I.C.E exhaust vented caging system offers a unique means of rodent housing in the animal care industry. The M.I.C.E. system is unmatched in its ability to house rodents in the best possible environmental conditions. The convection-assisted, low velocity, one pass airflow through each cage provides animals with the gentle ventilation necessary to ensure maximum comfort in an ideal, low-stress living and breeding environment. With no motors or blowers, M.I.C.E. equipped rooms are virtually noise, vibration, and odor-free.

S5 Rack Specifications M85010S5 70-Cage Mouse Rack/M85011S5 35-Cage Rat Rack

5-Module Single Sided Rack Assembly, Polycarbonate (also available in Polysulfone)

- Includes complete rack assembly with shelves, legs, casters, and 2 vent hose assemblies
- Includes 70 mouse cage assemblies or 35 rat cage assemblies
- 81.25”L x 23.25”D x 77.0” H
- 722 lbs including 70 mouse cage or 35 rat cage assemblies
- Rack assembly is mounted on stainless steel casters with 4” diameter wheels
- Minimum air flow requirements – 40 CFM per rack

| Cage Specific Information | |
|--|--|
| Mouse Cage | Rat Cage |
| Outside dims - 15.3” L x 7.8” W x 9.5” H | Outside dims – 15.3” L x 15.8” W x 9.5” H |
| Inside dims - 13.5” L x 7.0” W | Inside dims – 13.5” L x 14.9” W |
| Bottom inner dims – 12.1” L x 6.12” W | Bottom inner dims – 12.1” L x 14.0” W |
| Floor area – 83 square inches | Floor area – 180 square inches |
| Average height – 6.75” | Average height – 6.75” |
| Capacity – 6 - 25g mice; 2 – 300g rats; 5 – 100g hamsters | Capacity-15 – 25g mice; 6 – 300g rats; 100 – 100g hamsters |
| Cage Material – Makrolon polycarbonate or Udel polysulfone | Cage Material – Makrolon polycarbonate or Udel polysulfone |

The following items are available as options:

- Perforated stainless steel floor insert with integral feeder holder for bedding-free caging
- Cage bottoms can be equipped with stainless steel water valve grommets for an automatic watering system
- Inhalation nozzle that inserts into the front inlet port to deliver ‘test’ air directly into the cage
- Trough tunnel that fits under the feeder and provides enrichment for the animal population

This modular, closed-system, barrier isolation caging system provides maximum flexibility while increasing population density and improving the welfare of both animals and caretakers.

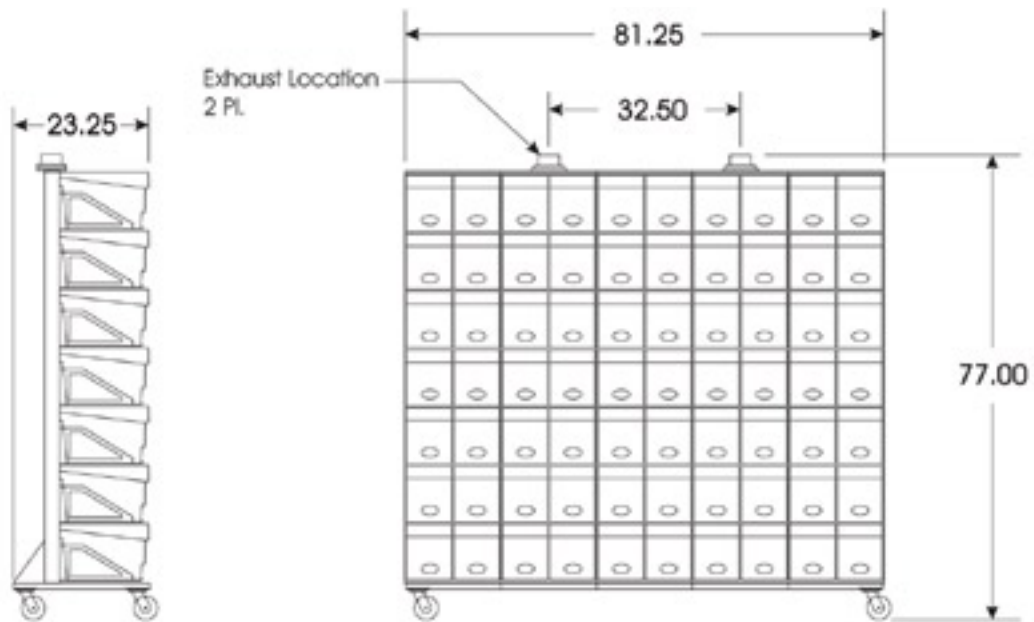

Weight – 722 Lbs with cages
 Minimum Ventilation – 40 CFM, 0.15" W.G.
 Ceiling Exhaust – 2 ea. 3" Dia. Duct**
 Exhaust Hoses – 3" Dia. Flexible x 10' Lg.

**Note that alternate exhaust such as 6" x 3" x 3" "Y" is acceptable

| | | |
|---|---------------------------------|--|
|  ANIMAL CARE SYSTEMS, INC. | Part Name: M85010S5 Rack | |
| | Engineering Specification Sheet | |
| Drawn by: S. Corelli | Date: 6/07/02 | |
| Revised: 6/22/02 | | |

M85011S5 Rack with 35 rat cages has identical specifications.
 P85011S5 Rack with 35 rat cages has identical specifications.

Sheet 2

The Cirrus SPF Misting Station by Animal Care Systems

Improve the productivity of your lab today!

The only alternative to ‘spray and pray’ pathogen removal

ACS' new, one-of-a-kind Cirrus SPF Misting Station is designed to eliminate many of the ergonomic, time-intensive and costly alternatives to disinfecting cages.

There is no other cage disinfecting system like it on the market today.

The Cirrus SPF Misting Station provides superior full-coverage disinfection in less than a second - automatically!

- Offers universal cage compatibility
- Eliminates costly pathogen outbreaks
- Saves time and money
- Improves occupational health
- Provides consistent coverage
- Collects excess chemicals for reuse
- Keeps animals healthy and pathogen-free

Features:

- Chemically inert fluid pumping and handling system
- Metered main spray with automatic activation
- Continuous spray gun with self-coiling hose
- Replaceable supply and waste bottles
- Spray shield with replaceable viewing window
- Height adjustability for superior ergonomics



“I am a supervisor for a 27 rodent-room facility. Thoroughly disinfecting the cages and other pieces of equipment we use with clidox is critical to keeping our facility disease-free (we’ve been disease-free for more than four years). The SPF Misting Station provides more thorough coverage of disinfectant, and requires less repetitive motion for employees, which causes injury and loss of work time.”

~Facility Supervisor, Department of Comparative Medicine, University of Washington

Cirrus SPF Misting Station

Technical Information

- Chemically inert fluid pumping and handling system
- Metered main spray with automatic activation
- Continuous spray gun with self-coiling hose
- Replaceable supply and waste bottles
- Superior overspray protection
- Height adjustability for superior ergonomics

| Specifications | |
|-------------------------|---|
| Power Input | 120VAC, 60Hz or 220 VAC, 50 Hz |
| Controls | Power on/off, prime, height adjustment, foot switch |
| Height Adjustment Range | 12 in. (305 mm) |
| Basin | Chemically resistant plastic |
| Pump | Chemically resistant plastic surfaces |
| Nozzles | Chemically resistant plastic. 6 total, 2 each front and back, 1 each left and right |
| Fluid Handling | Chemically resistant plastic and rubber |
| Fluid Reservoirs | 1 liter Nalgene bottles |
| Approved Disinfectant | Commercial chlorine dioxide solution |
| Weight | 155 lbs (70.3 kg) |
| Footprint | W20.00" (508 mm) x D18.00" (457 mm) x H63.00" (1600 mm) max |
| Casters | 4" diameter swivel, two locking casters |
| Agency Approvals | ETL, RoHS compliant |

Improve the productivity of your lab today!
The Cirrus SPF Misting Station by Animal Care Systems

Pioneering Technology
Superior Design
Exceptional Service



Animal Care
Systems

7086 South Revere Parkway | Centennial, Colorado 80112
Toll Free 1-888-827-3861 | Telephone 720-283-0177 | Fax 720-283-0179
www.AnimalCareSystems.com